

LF LED Wall Light **DESIGNER PREMIUM**



PROJECT

CATALOG #

TYPE

NOTES

The LF is our LED under-the-cap hardscape wall light. It can easily be fitted between a block wall and capstone for a neat, clean installation. Due to its modular bracket design, the LF can even be installed under railings and existing construction.

Quick Facts

- Die-cast brass housing
- Natural, powder coated, or antiqued brass finishes
- Lumileds® Integrated LEDs
- Compatible with Luxor® technology
- Phase and PWM dimmable
- Input voltage: 10-15V

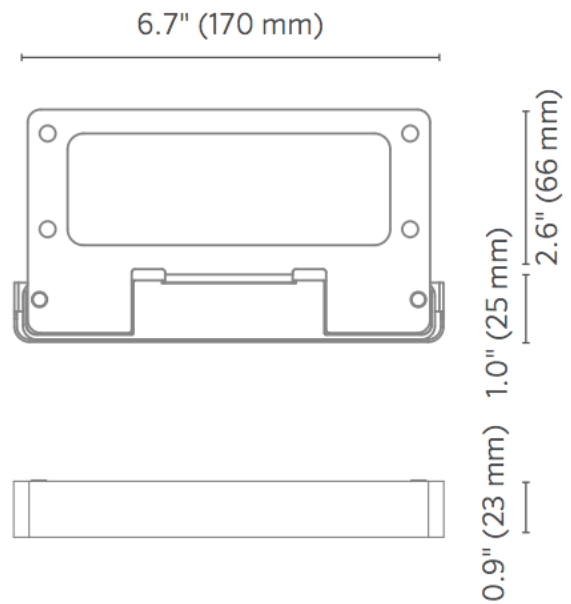

LF LED Wall Light SPECIFICATIONS

	1LED	ZDC
Total Lumens (lm)	95	34
Power Consumption (VA)	2.2	4.3
Efficacy (Lumens/Watt)	52	21
Maximum Candela (cd)	38	17
Color Temperature (CCT)	2700K	RGBW
Color Rendering Index (CRI)	84	-
Input Voltage (V)	10 to 15	11 to 15
BUG Rating	B0-U1-G0	B0-U1-G0
Dimming	Luxor, Phase (Trailing Edge)	Luxor
Minimum Rated Life (L70 B10)	72,000 Hrs	55,000 Hrs

LF LED Wall Light SPECIFICATIONS

About FX Luminaire

As a leading manufacturer of landscape and architectural lighting, FX Luminaire provides innovative products, resources, and support to help customers bring their visions to life. The company offers a range of specification-driven solutions, including fixtures, controls, and accessories, to enhance residential and commercial landscapes.

Materials

Die-cast C360 brass or A380 aluminum housing with stainless steel, brass, or copper faceplate (when applicable) and hardware.

LED

Integrated module with Cree LEDs. Gold-plated connectors and conformal coated for maximum reliability and corrosion resistance. Proprietary on-board intelligent driver uses firmware-controlled temperature regulation, maximizing LED life. Field upgradeable and replaceable, the LEDs are rated to 50,000 hrs. Maximum drive current: 1 A.

Optics

Polycarbonate color temperature adjustment lenses included with fixture: 2,700K (preinstalled), 3,900K (no lens). Color temperature lenses are field serviceable.

Finish

Options of natural copper/brass, stainless steel finish, powder coated, or antiqued finish with brushed (Antique Bronze) or tumbled (Antique Tumbled) effect. Antique finishes sealed with a clear TGIC powder coat layer.

Hardware

Stainless steel acorn nuts for tamper-resistance and proper adjustment.

Wiring

18 AWG (1 mm); SPT-1W; 220°F (105°C); 300V; 10' (3 m) length.

Sockets

Socket contains MoistureBlock™ technology, preventing moisture from wicking up into sealed areas of the fixture.

Power

Input 10–15 VAC/VDC, 50/60 Hz. Remote transformer required (specify separately).

Housing

Die-cast brass or aluminum housing with capacity for rectangular 1LED integrated LED.

Weight

1.0 lb. (0.5 kg)

Lens

Frosted polycarbonate lens with high tolerance for thermal expansion, stress, and abuse.

Ambient Operating Temperature

0°F to 140°F (-18°C to 60°C)

Installation Requirements

Designed for installation in the downward lighting direction only.

Control













ZD and ZDC options utilize Luxor technology to zone light fixtures in up to 250 groups, dim each group in 1% increments between 0 and 100%, or change to one of 30,000 colors with RGBW LEDs. Select the ZD option for zoning/dimming or ZDC for zoning/dimming/color. Standard fixture is zoneable with Luxor.

Warranty

Listings



LF LED Wall Light ORDERING INFORMATION

FixtureControl	Power	Color Temp	Compliance	Finish
LF [Default] Zone with Luxor, On/Off, Phase Dimmable	1 LED 2.0W/2.4VA	W Warm (2700K)	[default] North America (UL Listed)	BZ Bronze Metallic 
ZD Zone/Dim with Luxor	[default ZDC option] 3.6W/4.3VA	S Soft (3000K)	E International (CE Certified)	FB Black 
ZDC Zone/Dim/Color with Luxor		C Cool (4000K)		DG Desert Granite 
		[Default] RGBW, ZDC Option Required		WI Weathered Iron 
				SB Sedona Brown 
				FW Flat White 
				SV Silver 
				BSAB Antique Bronze on Brass 
				CUAB Antique Bronze on Copper 
				CU Copper 
				BS Natural Brass 
				SS Stainless Steel 



EXAMPLE FIXTURE CONFIGURATION: LF-ZD-1LED-W-BZ

*Includes Mounting Plate (755300)

LF-1LED - Illuminance at a Distance



Distance	Center Beam fc	Beam Width	
Feet (Meters)	Foot-Candles (Lux)	Vertical : 100.7°	Horizontal : 107.0°
1' (0.3 m)	37 fc (398 lx)	2.4 ft (0.7 m)	2.7 ft (0.8 m)
2.0' (0.6 m)	9.3 fc (100 lx)	4.8 ft (1.5 m)	5.4 ft (1.6 m)
3' (0.9 m)	4.1 fc (33 lx)	7.2 ft (2.2 m)	8.1 ft (2.5 m)
4.0' (1.2 m)	2.3 fc (25 lx)	9.6 ft (2.9 m)	10.8 ft (3.3 m)
5.0' (1.5 m)	1.5 fc (16 lx)	12.1 ft (3.7 m)	13.5 ft (4.1 m)
6.0' (1.8 m)	1 fc (11 lx)	14.5 ft (4.4 m)	16.5 ft (5.0 m)

LF ZDC - Illuminance at a Distance

Distance	Center Beam fc	Beam Width
Feet (Meters)	Foot-Candles (Lux)	

LF LED Wall Light ORDERING INFORMATION

POWER OPTIONS: Specify Separately

Power	Catalog No.	
Plug-In Transformer, 6 W	MT-6W	
	SURGE-MOD	

Power	Catalog No.	
Step-Down Transformer, UV (120/277 V to 12 V)	ST-UV	