



PROJECT

CATALOG #

TYPE

NOTES

C-WW STANDARD PLUS

Made with durable, midgrade brass, the elegant C-WW wall wash is a perfect addition to lighting projects for clients with modest budgets. Because of its corrosion-resistant construction, it's especially at home in coastal regions.

Quick Facts

- Midgrade brass construction
- Corrosion-resistant design
- Attractive antique bronze finish
- G4 lamp base
- Includes fixture, specified lamp, and spike
- Input voltage: 10-15V

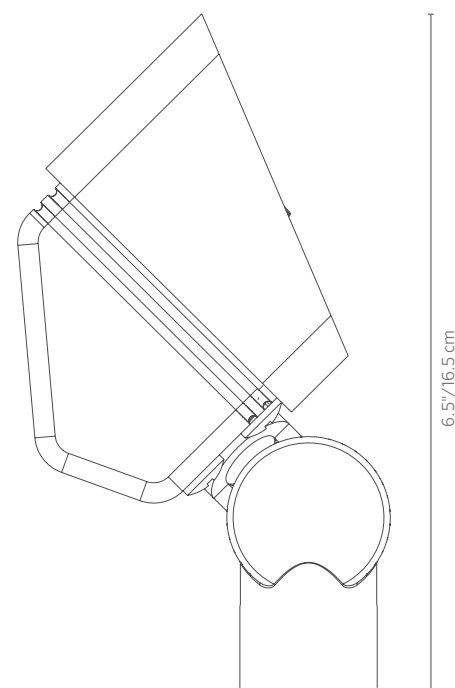

C-WW Wall Wash SPECIFICATIONS

Lamp	LED-20W
Halogen Lumen Output Equivalent	20W
Minimum Rated Life (L70)	33,000 hrs
Input Voltage	10 to 15V
Input Power	1.6W
VA Total (Use this number to size the transformer)	1.7W
Total Lumens	33
Lumens per Watt (Efficacy)	28
CRI (Ra)	80+
Center Beam Candle Power (CBCP)	22
Dimming	Phase
Luxor Compatibility	
ZD Option	Use Luxor Cube (LCM-LV)

FX Luminaire

FX Luminaire is an industry-leading manufacturer of landscape and architectural lighting products with a focus on the advancement of LED technology and digital lighting control with zoning, dimming, and color adjustment capabilities. We offer a full spectrum of highly efficient lighting fixtures that can be utilized to create elegant, cutting-edge landscape lighting systems for commercial or residential applications. Our products are available exclusively via our extensive professional distributor network.

Materials

Die-cast mid-grade brass housing/knuckle assembly with brass hardware.

Lamp

G4 lamp base. Preinstalled G4 LED lamp option offers a warm 2,700K color temperature with a minimum rated life (L70) of 40,000 hours.

Socket

G4 socket. Ceramic socket base with heat-resistant contact pad.

Wiring

18 AWG SPT-1W 105°C 300V 3-meter length

Power

Input 10-15VAC/VDC 50/60Hz. Remote transformer required (specify separately).

Lens

Tempered glass lens with shock resistance and high tolerance for thermal expansion and stress.

Finish

Antiqued finish with brushed effect.

Weight

2.2 lbs.

Manufacturing

9001:2015 certified facility

Hardware

¼-20 thumbscrew. Includes 10" polycarbonate slotted installation spike.

Ambient Operating Temperature

-30°F to 140°F

Sustainability

Innovation meets conservation in the design and manufacturing of our products. Where we can, we use recycled materials while maintaining superior functionality. Our LED products provide high-quality light at optimal energy efficiency, lifespan, and durability.

Installation Requirements

Designed for installation in the upward direction only.

Warranty

10-year limited warranty on luminaire; 5-year limited warranty on preinstalled FX LED lamp; no warranty on incandescent or halogen lamp.

Listings



C-WW Wall Wash ORDERING INFORMATION

Fixture	Lamp Option	Finish
C-WW*	<ul style="list-style-type: none"> LED20W (1.6W LED LAMP) 20W Equivalent LED Lamp, 2,700K 	<ul style="list-style-type: none"> AB Antique Bronze 







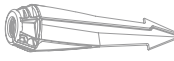

EXAMPLE FIXTURE CONFIGURATION:

C-WW-LED20W-AB

* Ships with Long Slot Spike



MOUNTING OPTIONS: Specify Separately

Mounts	Catalog No.	
<ul style="list-style-type: none"> SUPER SLOT SPIKE 2.5" 6.3 cm x 10" 25.4 cm 	753900	
<ul style="list-style-type: none"> LONG SLOT SPIKE 2.5" 6.3 cm x 10" 25.4 cm 	250015840000	
<ul style="list-style-type: none"> SUPER J-BOX 2.5" 6.3 cm x 12" 30.5 cm 	SJ-XX*	
<ul style="list-style-type: none"> 3-PRONG SPIKE 5.1" 6.3 cm x 9.0" 22.9 cm 	250020020000t	
<ul style="list-style-type: none"> PROAIM™ RATCHETING SPIKE 2.5" 6.3 cm x 10" 25.4 cm 	PARS	
<ul style="list-style-type: none"> POST MOUNT 2.5" 6.3 cm x 13" 33 cm 	PM-XX*	
<ul style="list-style-type: none"> VERSABOX 2.2" 5.7 cm x 1.5" 3.9 cm 	VB-050-XX*	
<ul style="list-style-type: none"> MINI J-BOX 3.5" 8.9 cm x 1.3" 3.4 cm 	MJ-050-XX*	

* YY = riser height in inches (6" increments between 6" and 36"),
XX = finish code

RISER OPTIONS: Specify Separately

Riser	Code	
<ul style="list-style-type: none"> RISER 0.8" 2.1 cm Diameter 	YY-R-GT-XX*	

LUXOR® TECHNOLOGY OPTIONS: Specify Separately

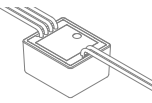
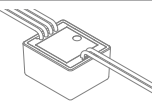
Cubes	Code	
<ul style="list-style-type: none"> LOW-VOLTAGE CUBE Supports AC dimmable LEDs and incandescent MAX LOAD: 60W/5A 	LCM-LV	
<ul style="list-style-type: none"> RELAY/0-10V CUBE Supports relay switch MAX LOAD: 250VAC/5A 	LCM-RLY-010V	

C-WW Wall Wash PHOTOMETRICS

C-WW Illuminance at a Distance

Feet	Center Beam	Beam Width	
		Vertical 68.7°	Horizontal 74.0°
2 ft	5.6 fc	2.7 ft	3.0 ft
4 ft	1.4 fc	5.5 ft	6.0 ft
6 ft	0.6 fc	8.2 ft	9.0 ft
8 ft	0.4 fc	10.9 ft	12.0 ft
10 ft	0.2 fc	13.7 ft	15.1 ft
12 ft	0.0 fc	16.4 ft	18.1 ft