

Harco Fittings LLC Price List

Ductile Iron IPS & DIPS Fittings for PVC Pipe



ENGINEERED FOR DURABILITY

1½" - 12" Push Joint Fittings, Joint Restraints, and Valves for IPS PVC Pipe

14" - 16" Fittings and Joint Restraints for DIPS PVC Pipe

FREIGHT TERMS - F.O.B Lynchburg, Virginia

ALL FITTINGS MEET OR EXCEED:

Materials:	ASTM A-536
Joints:	AWWA C-111
Gaskets:	ASTM F-477
Coating	AWWA C-153

Applicable U.S. Patents: #5,183,298; #5,464,257; #7,055,865; #7,255,124; #7,552,949

Harco Fittings LLC Price List

Ductile Iron IPS & DIPS Fittings for PVC Pipe

Fittings		CAT
Repair Couplings	4	A
Bends	5-6	A
Tees	7-10	A
S.E.B. and L.E.B. Reducers	11-12	A
Wyes	13	A
Side Outlet Tapped Caps	13	A
Tapped Tees and ACME Service Tees	14-15	A
Caps and Plugs	16	A
Tapped Caps and Plugs	17-18	A
Flange Adapters, Flange Outlet Tees, and Accessories	19-20	A
Male and ACME Adapters	20	A
Replacement, MJ and PJ Gaskets	21	A
Links and Retainer Clips	22	A
Crossover Rings	22	A
Polyethylene Encasement	22	A
Saddles		
Saddles, Single and Double Strap	23-24	B
Lateral Isolation Valves		
Lateral Isolation Valves	25	C
LIV Spare Parts	25	C
Valve Keys and Stiffeners	26	C
Swivel Joint Lateral Connection Systems		
Swivel Tees and Saddles	27-28	D
Swivel Extensions and Adapters	28-29	D
Swivel Lateral 90°s	30	D
Swivel Lateral Nipples	31	D
Lateral Connection Kits	32	D
Swing Joints	33	D
Special 1½" Swivel Tees, Kits & Adapters	34	D

Joint Restraints

Knuckle	35	E
Fitting to Pipe	35	E
Quick Coupler Anchor	35	E
Pipe to Pipe	36	E
Fitting to Valve	36	E
Fitting to Valve to Pipe	36	E
Valve to Pipe	36-37	E
Factory Beveled Spigots	37	E
Restraint Rods & Bolts	38	E
PE Stiffeners	38	E

Threaded Fittings

Threaded Fittings	39-41	F
Nipples	41	F

Conditions of Sale

(Back Cover)

NOTES

1. GASKETS — Included in prices unless otherwise noted.
2. CONNECTION LINKS — Are included in the price and shipped automatically with each S.E.B. reducer, solid and tapped plug, and spigot x flange adapter.
3. CEMENT LINING — Per AWWA C153. Available upon request. Add 5% to list prices, please specify on purchase order and allow up to two weeks for shipment. Cement lined fittings are non-cancellable, non-returnable, and non-refundable.
4. OTHER COATINGS available upon request. Call for pricing and lead times.
Non-cancellable. Returnable value subject to restock and coating charge.
5. ADDITIONAL ITEMS — Many additional configurations are possible by assembling standard fittings. Please inquire if fittings required are not in this list.
6. SUITABILITY — THE PRESENCE OF CORROSIVE SOILS OR CARRIED WATER MAY REQUIRE THE USE OF PROTECTIVE MEASURES SUCH AS POLYETHYLENE ENCASEMENT AND/OR COATINGS.
7. FITTINGS FOR DIPS PVC PIPE. DIPS fittings fit PVC pipe made to AWWA C900, made to Cast Iron OD diameters.
8. DOMESTIC PRODUCTS - A limited number of domestic fittings and restraints are available. Please call.

Harco Fittings LLC Price List

Fittings

REPAIR COUPLING



(Knock-On, No Stop)

SIZE	PART NUMBER	WT	LIST PRICE
Standard Bituminous Coating			
1½	80040	6	\$73.99
2	80140	6	\$73.99
2½	80240	7	\$95.00
3	80340	10	\$124.81
4	80440	12	\$157.12
6	80640	23	\$245.22
8	80840	33	\$303.23
10	81040	57	\$488.91
12	81240	71	\$643.46
14	81440MJ	193	\$2,013.62
16	81640MJ	232	\$2,350.39
Fusion Bonded Coating			
1½	80040F	6	\$96.18
2	80140F	6	\$96.18
2½	80240F	7	\$123.49
3	80340F	10	\$162.25
4	80440F	12	\$204.26
6	80640F	23	\$318.79
8	80840F	33	\$394.19
10	81040F	57	\$635.58
12	81240F	71	\$836.49
14	81440MJFS	193	\$2,617.70
16	81640MJFS	232	\$3,055.51

MJ fittings include Standard Accessories

MJFS fittings include FBC Gland and SS hardware

90° BEND

(1/4 Bend)

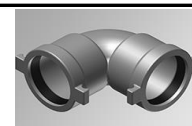

(Bell x Bell)

SIZE	PART NUMBER	WT	LIST PRICE
Standard Bituminous Coating			
1½	80020	4	\$55.50
2	80120	7	\$100.60
2½	80220	7	\$109.26
3	80320	10	\$145.67
4	80420	15	\$169.96
6	80620	27	\$338.18
8	80820	42	\$435.31
10	81020	77	\$830.73
12	81220	102	\$868.88
14	81420MJ	230	\$2,716.21
16	81620MJ	309	\$4,843.92
Fusion Bonded Coating			
1½	80020F	4	\$72.14
2	80120F	7	\$130.77
2½	80220F	7	\$142.04
3	80320F	10	\$189.37
4	80420F	15	\$220.95
6	80620F	27	\$439.64
8	80820F	42	\$565.91
10	81020F	77	\$1,079.95
12	81220F	102	\$1,129.54
14	81420MJFS	230	\$3,531.07
16	81620MJFS	309	\$6,297.09

MJ fittings include Standard Accessories

MJFS fittings include FBC Gland and SS hardware

NOTE:

- Fittings are Push Joint (PJ) unless denoted by "MJ" part number suffix as Mechanical Joint.
- 1½" - 12": Bells and spigots are IPS size unless noted otherwise.
- 14" - 16": Bells and spigots are DIPS size.
- Figures are representative and may not reflect exact form.

The HARCO Ductile Iron Fitting product line of easily connected modular components is covered by US Patent #5,183,298. Products in this price list are mostly import. A limited number of domestic configurations available.

Harco Fittings LLC Price List

Fittings

45° BEND (1/8 Bend)			
			
(Bell x Bell)			
SIZE	PART NUMBER	WT	LIST PRICE
Standard Bituminous Coating			
* 1½	80022	7	\$186.49
2	80122	5	\$98.87
2½	80222	6	\$100.60
3	80322	9	\$126.61
4	80422	13	\$156.09
6	80622	23	\$254.95
8	80822	37	\$398.89
10	81022	56	\$596.59
12	81222	75	\$856.74
14	81422	180	\$1,914.87
16	81622	266	\$2,575.25
Fusion Bonded Coating			
* 1½	80022F	7	\$242.44
2	80122F	5	\$128.53
2½	80222F	6	\$130.77
3	80322F	9	\$164.59
4	80422F	13	\$202.92
6	80622F	23	\$331.43
8	80822F	37	\$518.56
10	81022F	56	\$775.56
12	81222F	75	\$1,113.76
14	81422F	180	\$2,489.33
16	81622F	266	\$3,347.83

* Assembled from subcomponents

22½° BEND (1/16 Bend)			
			
(Bell x Bell)			
SIZE	PART NUMBER	WT	LIST PRICE
Standard Bituminous Coating			
2½	80224	7	\$104.06
3	80324	8	\$128.34
4	80424	12	\$156.09
6	80624	21	\$215.05
8	80824	32	\$385.01
10	81024	51	\$721.47
12	81224	77	\$731.86
14	81424MJ	180	\$2,166.55
16	81624MJ	269	\$3,159.34
Fusion Bonded Coating			
2½	80224F	7	\$135.28
3	80324F	8	\$166.84
4	80424F	12	\$202.92
6	80624F	21	\$279.57
8	80824F	32	\$500.51
10	81024F	51	\$937.91
12	81224F	77	\$951.42
14	81424MJFS	180	\$2,816.51
16	81624MJFS	269	\$4,107.15

MJ fittings include Standard Accessories

MJFS fittings include FBC Gland and SS hardware

NOTE:

- Fittings are Push Joint (PJ) unless denoted by "MJ" part number suffix as a Mechanical Joint.
- 1½" - 12": Bells and spigots are IPS size unless noted otherwise.
- 14" - 16": Bells and spigots are DIPS size.
- Figures are representative and may not reflect exact form.

The HARCO Ductile Iron Fitting product line of easily connected modular components is covered by US Patent #5,183,298. Products in this price list are mostly import. A limited number of domestic configurations available.

Harco Fittings LLC Price List

Fittings

11¼° BEND (1/32 Bend)			
(Bell x Bell)			
SIZE	PART NUMBER	WT	LIST PRICE
Standard Bituminous Coating			
4	80426	10	\$185.58
6	80626	21	\$280.95
8	80826	35	\$385.01
10	81026	56	\$775.23
12	81226	77	\$990.29
14	81426MJ	180	\$2,161.70
16	81626MJ	271	\$2,816.07
Fusion Bonded Coating			
4	80426F	10	\$241.26
6	80626F	21	\$365.24
8	80826F	35	\$500.51
10	81026F	56	\$1,007.79
12	81226F	77	\$1,287.37
14	81426MJFS	180	\$2,810.21
16	81626MJFS	271	\$3,660.89

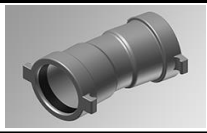

MJ fittings include Standard Accessories

MJFS fittings include FBC Gland and SS hardware

NOTE:

- Fittings are Push Joint (PJ) unless denoted by "MJ" part number suffix as a Mechanical Joint.
- 1½" - 12": Bells and spigots are IPS size unless noted otherwise.
- 14" - 16": Bells and spigots are DIPS size.
- Figures are representative and may not reflect exact form.

The HARCO Ductile Iron Fitting product line of easily connected modular components is covered by US Patent #5,183,298. Products in this price list are mostly import. A limited number of domestic configurations available.

Harco Fittings LLC Price List

Fittings

TEE			
(Bell x Bell x Bell)			
SIZE	PART NUMBER	WT	LIST PRICE
Standard Bituminous Coating			
1½	8000000	6.1	\$101.31
2 x 1½ x 1½	8010000	20	\$341.66
2 x 1½ x 2	8010001	14	\$254.95
2 x 2 x 1½	8010100	12	\$171.70
2	8010101	8	\$104.06
2 x 2 x 2½	8010102	9	\$283.40
2 x 2 x 3	8010103	10	\$310.43
2 x 2 x 4	8010104	37	\$466.52
2 x 2 x 6	8010106	78	\$875.82
2½ x 1½ x 1½	8020000	21	\$348.60
2½ x 1½ x 2	8020001	16	\$355.53
2½ x 1½ x 2½	8020002	19	\$357.26
2½ x 2 x 1½	8020100	16	\$272.28
2½ x 2 x 2	8020101	17	\$263.62
2½ x 2 x 2½	8020102	17	\$201.17
2½ x 2 x 3	8020103	19	\$327.79
2½ x 2½ x 1½	8020200	11	\$252.58
2½ x 2½ x 2	8020201	9	\$220.26
2½	8020202	10	\$114.46
2½ x 2½ x 3	8020203	12	\$241.08
2½ x 2½ x 4	8020204	40	\$466.52
2½ x 2½ x 6	8020206	80	\$784.15
3 x 2 x 2	8030101	13	\$338.18
3 x 2 x 2½	8030102	19	\$341.66
3 x 2 x 3	8030103	21	\$291.37
3 x 2 x 4	8030104	41	\$473.45
3 x 2½ x 1½	8030200	21	\$371.14
3 x 2½ x 2	8030201	21	\$352.07
3 x 2½ x 2½	8030202	11	\$353.78
3 x 2½ x 3	8030203	21	\$308.69
3 x 2½ x 4	8030204	41	\$473.45
3 x 3 x 1½	8030300	14	\$273.13
3 x 3 x 2	8030301	12	\$246.26
3 x 3 x 2½	8030302	12	\$254.95
3	8030303	14	\$204.66
3 x 3 x 4	8030304	42	\$473.45
3 x 3 x 6	8030306	66	\$830.73
4 x 2 x 2	8040101	25	\$383.28
4 x 2 x 2½	8040102	26	\$385.01
4 x 2 x 3	8040103	27	\$390.21
4 x 2 x 4	8040104	31	\$362.47
4 x 2 x 6	8040106	72	\$816.85
4 x 2½ x 2	8040201	25	\$412.75



TEE			
(Bell x Bell x Bell)			
SIZE	PART NUMBER	WT	LIST PRICE
Fusion Bonded Coating			
1½	8000000F	6.1	\$131.70
2 x 1½ x 1½	8010000F	20	\$444.16
2 x 1½ x 2	8010001F	14	\$331.43
2 x 2 x 1½	8010100F	12	\$223.21
2	8010101F	8	\$135.28
2 x 2 x 2½	8010102F	9	\$368.43
2 x 2 x 3	8010103F	10	\$403.56
2 x 2 x 4	8010104F	37	\$606.48
2 x 2 x 6	8010106F	78	\$1,138.57
2½ x 1½ x 1½	8020000F	21	\$453.18
2½ x 1½ x 2	8020001F	16	\$462.19
2½ x 1½ x 2½	8020002F	19	\$464.44
2½ x 2 x 1½	8020100F	16	\$353.97
2½ x 2 x 2	8020101F	17	\$342.70
2½ x 2 x 2½	8020102F	17	\$261.52
2½ x 2 x 3	8020103F	19	\$426.13
2½ x 2½ x 1½	8020200F	11	\$328.36
2½ x 2½ x 2	8020201F	9	\$286.34
2½	8020202F	10	\$148.79
2½ x 2½ x 3	8020203F	12	\$313.40
2½ x 2½ x 4	8020204F	40	\$606.48
2½ x 2½ x 6	8020206F	80	\$1,019.39
3 x 2 x 2	8030101F	13	\$439.64
3 x 2 x 2½	8030102F	19	\$444.16
3 x 2 x 3	8030103F	21	\$378.78
3 x 2 x 4	8030104F	41	\$615.49
3 x 2½ x 1½	8030200F	21	\$482.48
3 x 2½ x 2	8030201F	21	\$457.69
3 x 2½ x 2½	8030202F	11	\$459.92
3 x 2½ x 3	8030203F	21	\$401.30
3 x 2½ x 4	8030204F	41	\$615.49
3 x 3 x 1½	8030300F	14	\$355.07
3 x 3 x 2	8030301F	12	\$320.13
3 x 3 x 2½	8030302F	12	\$331.43
3	8030303F	14	\$266.05
3 x 3 x 4	8030304F	42	\$615.49
3 x 3 x 6	8030306F	66	\$1,079.95
4 x 2 x 2	8040101F	25	\$498.27
4 x 2 x 2½	8040102F	26	\$500.51
4 x 2 x 3	8040103F	27	\$507.28
4 x 2 x 4	8040104F	31	\$471.21
4 x 2 x 6	8040106F	72	\$1,061.90
4 x 2½ x 2	8040201F	25	\$536.58



Harco Fittings LLC Price List

Fittings

TEE (continued)			
(Bell x Bell x Bell)			
SIZE	PART NUMBER	WT	LIST PRICE
Standard Bituminous Coating			
4 x 2½ x 2½	8040202	26	\$357.26
4 x 2½ x 3	8040203	27	\$357.26
4 x 2½ x 4	8040204	31	\$357.26
4 x 2½ x 6	8040206	74	\$826.73
4 x 3 x 2	8040301	26	\$362.47
4 x 3 x 2½	8040302	27	\$362.47
4 x 3 x 3	8040303	26	\$362.47
4 x 3 x 4	8040304	32	\$362.47
4 x 3 x 6	8040306	64	\$813.38
4 x 4 x 1½	8040400	16	\$277.49
4 x 4 x 2	8040401	16	\$249.73
4 x 4 x 2½	8040402	17	\$254.95
4 x 4 x 3	8040403	18	\$261.89
4	8040404	21	\$265.35
4 x 4 x 6	8040406	70	\$797.76
4 x 4 x 8	8040408	86	\$994.13
6 x 2 x 4	8060104	52	\$626.09
6 x 2 x 6	8060106	58	\$626.09
6 x 2 x 8	8060108	111	\$982.38
6 x 2½ x 3	8060203	49	\$534.16
6 x 2½ x 4	8060204	53	\$600.06
6 x 2½ x 6	8060206	59	\$626.09
6 x 2½ x 8	8060208	116	\$1,054.45
6 x 3 x 2	8060301	41	\$506.42
6 x 3 x 2½	8060302	42	\$535.90
6 x 3 x 3	8060303	44	\$535.90
6 x 3 x 4	8060304	47	\$600.06
6 x 3 x 6	8060306	53	\$627.81
6 x 3 x 8	8060308	88	\$1,080.46
6 x 4 x 2	8060401	43	\$522.02
6 x 4 x 2½	8060402	43	\$522.75
6 x 4 x 3	8060403	45	\$522.75
6 x 4 x 4	8060404	48	\$596.59
6 x 4 x 6	8060406	54	\$615.68
6 x 4 x 8	8060408	88	\$1,066.58
6 x 6 x 1½	8060600	18	\$339.93
6 x 6 x 2	8060601	25	\$327.79
6 x 6 x 2½	8060602	26	\$336.45
6 x 6 x 3	8060603	28	\$336.45
6 x 6 x 4	8060604	31	\$402.35
6	8060606	37	\$428.37
6 x 6 x 8	8060608	88	\$1,066.58
6 x 6 x 10	8060610	164	\$1,833.15



TEE (continued)			
(Bell x Bell x Bell)			
SIZE	PART NUMBER	WT	LIST PRICE
Fusion Bonded Coating			
4 x 2½ x 2½	8040202F	26	\$464.44
4 x 2½ x 3	8040203F	27	\$464.44
4 x 2½ x 4	8040204F	31	\$464.44
4 x 2½ x 6	8040206F	74	\$1,074.75
4 x 3 x 2	8040301F	26	\$471.21
4 x 3 x 2½	8040302F	27	\$471.21
4 x 3 x 3	8040303F	26	\$471.21
4 x 3 x 4	8040304F	32	\$471.21
4 x 3 x 6	8040306F	64	\$1,057.40
4 x 4 x 1½	8040400F	16	\$360.73
4 x 4 x 2	8040401F	16	\$324.65
4 x 4 x 2½	8040402F	17	\$331.43
4 x 4 x 3	8040403F	18	\$340.45
4	8040404F	21	\$344.96
4 x 4 x 6	8040406F	70	\$1,037.09
4 x 4 x 8	8040408F	86	\$1,292.36
6 x 2 x 4	8060104F	52	\$813.91
6 x 2 x 6	8060106F	58	\$813.91
6 x 2 x 8	8060108F	111	\$1,277.09
6 x 2½ x 3	8060203F	49	\$694.41
6 x 2½ x 4	8060204F	53	\$780.08
6 x 2½ x 6	8060206F	59	\$813.91
6 x 2½ x 8	8060208F	116	\$1,370.78
6 x 3 x 2	8060301F	41	\$658.34
6 x 3 x 2½	8060302F	42	\$696.67
6 x 3 x 3	8060303F	44	\$696.67
6 x 3 x 4	8060304F	47	\$780.08
6 x 3 x 6	8060306F	53	\$816.16
6 x 3 x 8	8060308F	88	\$1,404.60
6 x 4 x 2	8060401F	43	\$678.62
6 x 4 x 2½	8060402F	43	\$679.58
6 x 4 x 3	8060403F	45	\$679.58
6 x 4 x 4	8060404F	48	\$775.56
6 x 4 x 6	8060406F	54	\$800.39
6 x 4 x 8	8060408F	88	\$1,386.56
6 x 6 x 1½	8060600F	18	\$441.91
6 x 6 x 2	8060601F	25	\$426.13
6 x 6 x 2½	8060602F	26	\$437.38
6 x 6 x 3	8060603F	28	\$437.38
6 x 6 x 4	8060604F	31	\$523.05
6	8060606F	37	\$556.88
6 x 6 x 8	8060608F	88	\$1,386.56
6 x 6 x 10	8060610F	164	\$2,383.10



Harco Fittings LLC Price List

Fittings

TEE (continued)			
(Bell x Bell x Bell)			
SIZE	PART NUMBER	WT	LIST PRICE
Standard Bituminous Coating			
8 x 2½ x 6	8080206	78	\$851.53
8 x 2½ x 8	8080208	86	\$851.53
8 x 3 x 6	8080306	79	\$853.26
8 x 3 x 8	8080308	87	\$853.26
8 x 4 x 4	8080404	67	\$842.86
8 x 4 x 6	8080406	74	\$842.86
8 x 4 x 8	8080408	82	\$842.86
8 x 4 x 10	8080410	217	\$2,115.82
8 x 6 x 2	8080601	60	\$714.52
8 x 6 x 2½	8080602	61	\$717.98
8 x 6 x 3	8080603	64	\$657.29
8 x 6 x 4	8080604	69	\$842.86
8 x 6 x 6	8080606	76	\$842.86
8 x 6 x 8	8080608	84	\$842.86
8 x 6 x 10	8080610	203	\$1,833.15
8 x 6 x 12	8080612	264	\$2,363.82
8 x 8 x 2	8080801	36	\$452.65
8 x 8 x 2½	8080802	36	\$459.59
8 x 8 x 3	8080803	39	\$428.37
8 x 8 x 4	8080804	44	\$610.46
8 x 8 x 6	8080806	51	\$615.68
8	8080808	61	\$620.87
8 x 8 x 10	8080810	205	\$1,833.15
8 x 8 x 12	8080812	265	\$2,363.82
10 x 3 x 8	8100308	127	\$1,186.25
10 x 3 x 10	8100310	146	\$1,408.64
10 x 3 x 12	8100312	258	\$4,415.72
10 x 4 x 6	8100406	143	\$1,633.68
10 x 4 x 8	8100408	153	\$1,663.18
10 x 4 x 10	8100410	172	\$1,663.98
10 x 4 x 12	8100412	285	\$2,636.11
10 x 6 x 4	8100604	119	\$1,531.37
10 x 6 x 6	8100606	127	\$1,342.33
10 x 6 x 8	8100608	137	\$1,371.82
10 x 6 x 10	8100610	156	\$1,387.42
10 x 6 x 12	8100612	260	\$2,438.39
10 x 8 x 3	8100803	120	\$1,203.58
10 x 8 x 4	8100804	120	\$1,531.37
10 x 8 x 6	8100806	127	\$1,361.40
10 x 8 x 8	8100808	138	\$1,373.55
10 x 8 x 10	8100810	157	\$1,387.42
10 x 8 x 12	8100812	274	\$2,438.39
10 x 10 x 2	8101001	70	\$775.23



TEE (continued)			
(Bell x Bell x Bell)			
SIZE	PART NUMBER	WT	LIST PRICE
Fusion Bonded Coating			
8 x 2½ x 6	8080206F	78	\$1,106.99
8 x 2½ x 8	8080208F	86	\$1,106.99
8 x 3 x 6	8080306F	79	\$1,109.24
8 x 3 x 8	8080308F	87	\$1,109.24
8 x 4 x 4	8080404F	67	\$1,095.72
8 x 4 x 6	8080406F	74	\$1,095.72
8 x 4 x 8	8080408F	82	\$1,095.72
8 x 4 x 10	8080410F	217	\$2,750.56
8 x 6 x 2	8080601F	60	\$928.87
8 x 6 x 2½	8080602F	61	\$933.38
8 x 6 x 3	8080603F	64	\$854.48
8 x 6 x 4	8080604F	69	\$1,095.72
8 x 6 x 6	8080606F	76	\$1,095.72
8 x 6 x 8	8080608F	84	\$1,095.72
8 x 6 x 10	8080610F	203	\$2,383.10
8 x 6 x 12	8080612F	264	\$3,072.97
8 x 8 x 2	8080801F	36	\$588.45
8 x 8 x 2½	8080802F	36	\$597.47
8 x 8 x 3	8080803F	39	\$556.88
8 x 8 x 4	8080804F	44	\$793.59
8 x 8 x 6	8080806F	51	\$800.39
8	8080808F	61	\$807.13
8 x 8 x 10	8080810F	205	\$2,383.10
8 x 8 x 12	8080812F	265	\$3,072.97
10 x 3 x 8	8100308F	127	\$1,542.13
10 x 3 x 10	8100310F	146	\$1,831.23
10 x 3 x 12	8100312F	258	\$5,740.43
10 x 4 x 6	8100406F	143	\$2,123.78
10 x 4 x 8	8100408F	153	\$2,162.13
10 x 4 x 10	8100410F	172	\$2,163.18
10 x 4 x 12	8100412F	285	\$3,426.94
10 x 6 x 4	8100604F	119	\$1,990.77
10 x 6 x 6	8100606F	127	\$1,745.03
10 x 6 x 8	8100608F	137	\$1,783.37
10 x 6 x 10	8100610F	156	\$1,803.64
10 x 6 x 12	8100612F	260	\$3,169.91
10 x 8 x 3	8100803F	120	\$1,564.65
10 x 8 x 4	8100804F	120	\$1,990.77
10 x 8 x 6	8100806F	127	\$1,769.83
10 x 8 x 8	8100808F	138	\$1,785.61
10 x 8 x 10	8100810F	157	\$1,803.64
10 x 8 x 12	8100812F	274	\$3,169.91
10 x 10 x 2	8101001F	70	\$1,007.79



Harco Fittings LLC Price List

Fittings

TEE (continued)			
(Bell x Bell x Bell)			
SIZE	PART NUMBER	WT	LIST PRICE
Standard Bituminous Coating			
10 x 10 x 2½	8101002	79	\$775.23
10 x 10 x 3	8101003	80	\$775.23
10 x 10 x 4	8101004	70	\$1,089.12
10 x 10 x 6	8101006	79	\$903.55
10 x 10 x 8	8101008	89	\$931.30
10	8101010	109	\$957.32
10 x 10 x 12	8101012	286	\$2,523.38
12 x 4 x 8	8120408	183	\$2,636.11
12 x 4 x 10	8120410	288	\$2,636.11
12 x 4 x 12	8120412	220	\$2,140.09
12 x 6 x 6	8120606	157	\$1,346.53
12 x 6 x 8	8120608	170	\$2,243.74
12 x 6 x 10	8120610	213	\$2,450.54
12 x 6 x 12	8120612	204	\$1,958.00
12 x 8 x 3	8120803	193	\$1,211.44
12 x 8 x 4	8120804	185	\$1,278.17
12 x 8 x 6	8120806	162	\$1,327.95
12 x 8 x 8	8120808	173	\$1,425.58
12 x 8 x 10	8120810	276	\$2,450.54
12 x 8 x 12	8120812	268	\$1,958.00
12 x 10 x 3	8121003	202	\$1,425.58
12 x 10 x 4	8121004	192	\$1,560.86
12 x 10 x 6	8121006	169	\$1,373.55
12 x 10 x 8	8121008	242	\$1,517.49
12 x 10 x 10	8121010	285	\$2,523.38
12 x 10 x 12	8121012	277	\$2,046.44
12 x 12 x 2	8121201	89	\$868.88
12 x 12 x 2½	8121202	90	\$868.88
12 x 12 x 3	8121203	133	\$872.34
12 x 12 x 4	8121204	116	\$1,082.19
12 x 12 x 6	8121206	100	\$893.16
12 x 12 x 8	8121208	112	\$1,028.43
12 x 12 x 10	8121210	214	\$2,412.09
12	8121212	147	\$1,560.86
14	8141414	286	\$3,163.27
16	8161616	335	\$3,767.45



TEE (continued)			
(Bell x Bell x Bell)			
SIZE	PART NUMBER	WT	LIST PRICE
Fusion Bonded Coating			
10 x 10 x 2½	8101002F	79	\$1,007.79
10 x 10 x 3	8101003F	80	\$1,007.79
10 x 10 x 4	8101004F	70	\$1,415.86
10 x 10 x 6	8101006F	79	\$1,174.62
10 x 10 x 8	8101008F	89	\$1,210.70
10	8101010F	109	\$1,244.51
10 x 10 x 12	8101012F	286	\$3,280.39
12 x 4 x 8	8120408F	183	\$3,426.94
12 x 4 x 10	8120410F	288	\$3,426.94
12 x 4 x 12	8120412F	220	\$2,782.12
12 x 6 x 6	8120606F	157	\$1,750.49
12 x 6 x 8	8120608F	170	\$2,916.86
12 x 6 x 10	8120610F	213	\$3,185.70
12 x 6 x 12	8120612F	204	\$2,545.40
12 x 8 x 3	8120803F	193	\$1,574.87
12 x 8 x 4	8120804F	185	\$1,661.62
12 x 8 x 6	8120806F	162	\$1,726.34
12 x 8 x 8	8120808F	173	\$1,853.25
12 x 8 x 10	8120810F	276	\$3,185.70
12 x 8 x 12	8120812F	268	\$2,545.40
12 x 10 x 3	8121003F	202	\$1,853.25
12 x 10 x 4	8121004F	192	\$2,029.11
12 x 10 x 6	8121006F	169	\$1,785.61
12 x 10 x 8	8121008F	242	\$1,972.74
12 x 10 x 10	8121010F	285	\$3,280.39
12 x 10 x 12	8121012F	277	\$2,660.37
12 x 12 x 2	8121201F	89	\$1,129.54
12 x 12 x 2½	8121202F	90	\$1,129.54
12 x 12 x 3	8121203F	133	\$1,134.05
12 x 12 x 4	8121204F	116	\$1,406.85
12 x 12 x 6	8121206F	100	\$1,161.10
12 x 12 x 8	8121208F	112	\$1,336.96
12 x 12 x 10	8121210F	214	\$3,135.72
12	8121212F	147	\$2,029.11
14	8141414F	286	\$4,112.25
16	8161616F	335	\$4,897.68



Tees may be assembled from multiple components.

Tees may be assembled from multiple components.

NOTE:

- 1½" - 12": Bells and spigots are IPS size unless noted otherwise.
- 14" - 16": Bells and spigots are DIPS size.
- Figures are representative and may not reflect exact form.

The HARCO Ductile Iron Fitting product line of easily connected modular components is covered by US Patent #5,183,298. Products in this price list are mostly import. A limited number of domestic configurations available.

Harco Fittings LLC Price List

Fittings

S.E.B. REDUCER			
U.S. Patent #5,183,298			
			
(Small End Bell; Spigot x Bell)			
SIZE	PART NUMBER	WT	LIST PRICE
Standard Bituminous Coating			
2 x 1½	80130	9	\$147.42
2½ x 1½	80232	11	\$161.54
2½ x 2	80230	6	\$91.92
3 x 2	80332	7	\$91.92
3 x 2½	80330	8	\$104.06
4 x 2	80434	9	\$111.00
4 x 2½	80432	9	\$111.00
4 x 3	80430	10	\$114.46
6 x 2	80638	19	\$201.17
6 x 2½	80636	20	\$204.66
6 x 3	80634	14	\$176.90
6 x 4	80632	16	\$195.99
8 x 2½	80838	26	\$241.08
8 x 3	80836	27	\$241.08
8 x 4	80834	21	\$232.41
8 x 6	80832	25	\$232.41
10 x 3	81036	31	\$256.67
10 x 4	81034	57	\$407.56
10 x 6	81032	42	\$407.56
10 x 8	81030	43	\$407.56
12 x 4	81236	67	\$596.59
12 x 6	81234	52	\$402.35
12 x 8	81232	55	\$402.35
12 x 10	81230	69	\$490.81
14 x 6	81434	148	\$1,860.49
14 x 8	81433	151	\$1,860.49
14 x 10	81432	159	\$1,710.74
14 x 12	81430	98	\$1,189.80
16 x 6	81635	179	\$2,343.62
16 x 8	81634	183	\$2,373.80
16 x 10	81633	192	\$2,424.90
16 x 12	81632	130	\$1,749.00

S.E.B. REDUCER			
U.S. Patent #5,183,298			
			
(Small End Bell; Spigot x Bell)			
SIZE	PART NUMBER	WT	LIST PRICE
Fusion Bonded Coating			
2 x 1½	80130F	9	\$191.65
2½ x 1½	80232F	11	\$210.00
2½ x 2	80230F	6	\$119.49
3 x 2	80332F	7	\$119.49
3 x 2½	80330F	8	\$135.28
4 x 2	80434F	9	\$144.30
4 x 2½	80432F	9	\$144.30
4 x 3	80430F	10	\$148.79
6 x 2	80638F	19	\$261.52
6 x 2½	80636F	20	\$266.05
6 x 3	80634F	14	\$229.97
6 x 4	80632F	16	\$254.78
8 x 2½	80838F	26	\$313.40
8 x 3	80836F	27	\$313.40
8 x 4	80834F	21	\$302.13
8 x 6	80832F	25	\$302.13
10 x 3	81036F	31	\$333.68
10 x 4	81034F	57	\$529.83
10 x 6	81032F	42	\$529.83
10 x 8	81030F	43	\$529.83
12 x 4	81236F	67	\$775.56
12 x 6	81234F	52	\$523.05
12 x 8	81232F	55	\$523.05
12 x 10	81230F	69	\$638.05
14 x 6	81434FS	148	\$2,418.63
14 x 8	81433FS	151	\$2,418.63
14 x 10	81432FS	159	\$2,223.96
14 x 12	81430FS	98	\$1,546.75
16 x 6	81635FS	179	\$3,046.70
16 x 8	81634FS	183	\$3,085.94
16 x 10	81633FS	192	\$3,152.36
16 x 12	81632FS	130	\$2,273.70

Two (2) links and two (2) wedges for each spigot side only of S.E.B. Reducer are included in price and shipped automatically. Some S.E.B. Reducers assembled from Tapped Plug and Male Adapter or multiple S.E.B. Reducers. 14" & 16" S.E.B. includes restraint rods required for connecting to fitting.

Two (2) links and two (2) wedges for each spigot side only of S.E.B. Reducer are included in price and shipped automatically. Some S.E.B. Reducers assembled from Tapped Plug and Male Adapter or multiple S.E.B. Reducers. 14" & 16" S.E.B. includes restraint rods required for connecting to fitting.

NOTE:

- 1½" - 12": Bells and spigots are IPS size unless noted otherwise.
- 14" - 16": Bells and spigots are DIPS size.
- Figures are representative and may not reflect exact form.

The HARCO Ductile Iron Fitting product line of easily connected modular components is covered by US Patent #5,183,298. Products in this price list are mostly import. A limited number of domestic configurations available.

Harco Fittings LLC Price List

Fittings

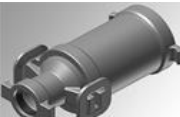
REDUCER			
(Bell x Bell)			
SIZE	PART NUMBER	WT	LIST PRICE
Standard Bituminous Coating			
2 x 1½	80130BB	13	\$235.86
2½ x 1½	80232BB	19	\$239.33
2½ x 2	80230BB	16	\$157.83
3 x 2	80332BB	17	\$195.99
3 x 2½	80330BB	17	\$209.85
4 x 2	80434BB	21	\$241.08
4 x 2½	80432BB	22	\$241.08
4 x 3	80430BB	23	\$246.26
6 x 2	80638BB	43	\$443.97
6 x 2½	80636BB	44	\$395.00
6 x 3	80634BB	38	\$402.35
6 x 4	80630	40	\$388.89
8 x 2½	80838BB	60	\$492.54
8 x 3	80836BB	61	\$579.84
8 x 4	80834BB	55	\$543.09
8 x 6	80830	58	\$586.96
10 x 6	81032BB	106	\$1,033.82
10 x 8	81030BB	107	\$1,010.32
12 x 6	81234BB	130	\$1,255.51
12 x 8	81232BB	134	\$1,287.19
12 x 10	81230BB	143	\$1,326.35
14 x 12	81430BB	250	\$3,658.09
16 x 12	81632BB	314	\$4,482.42
16 x 14	81630BB	343	\$4,682.01

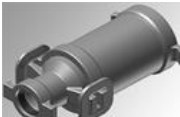
REDUCER			
(Bell x Bell)			
SIZE	PART NUMBER	WT	LIST PRICE
Fusion Bonded Coating			
2 x 1½	80130BBF	13	\$306.62
2½ x 1½	80232BBF	19	\$311.13
2½ x 2	80230BBF	16	\$205.18
3 x 2	80332BBF	17	\$254.78
3 x 2½	80330BBF	17	\$272.80
4 x 2	80434BBF	21	\$313.40
4 x 2½	80432BBF	22	\$313.40
4 x 3	80430BBF	23	\$320.13
6 x 2	80638BBF	43	\$577.16
6 x 2½	80636BBF	44	\$513.50
6 x 3	80634BBF	38	\$523.05
6 x 4	80630F	40	\$505.56
8 x 2½	80838BBF	60	\$640.30
8 x 3	80836BBF	61	\$753.80
8 x 4	80834BBF	55	\$706.02
8 x 6	80830F	58	\$763.05
10 x 6	81032BBF	106	\$1,343.97
10 x 8	81030BBF	107	\$1,313.41
12 x 6	81234BBF	130	\$1,632.16
12 x 8	81232BBF	134	\$1,673.34
12 x 10	81230BBF	143	\$1,724.25
14 x 12	81430BBF	250	\$4,755.52
16 x 12	81632BBF	314	\$5,827.15
16 x 14	81630BBF	343	\$6,086.61

L.E.B. REDUCER			
(Large End Bell; Bell x Spigot)			
SIZE	PART NUMBER	WT	LIST PRICE
Standard Bituminous Coating			
4 x 3	80431	10	\$114.46
Fusion Bonded Coating			
4 x 3	80431F	10	\$148.79

Links sold separately

NOTE:

- 1½" - 12": Bells and spigots are IPS size unless noted otherwise.
- 14" - 16": Bells and spigots are DIPS size.
- Figures are representative and may not reflect exact form.

The HARCO Ductile Iron Fitting product line of easily connected modular components is covered by US Patent #5,183,298. Products in this price list are mostly import. A limited number of domestic configurations available.

Harco Fittings LLC Price List

Fittings

WYE			
			
(Bell x Bell x Bell)			
SIZE	PART NUMBER	WT	LIST PRICE
Standard Bituminous Coating			
1½	80010B	10	\$185.58
2	80110B	12	\$209.85
Fusion Bonded Coating			
1½	80010BF	10	\$241.26
2	80110BF	12	\$272.80

While Supplies last

May be configured for any size gasketed branch 1½" up to run diameter.

WYE			
			
(Bell x Bell x Female NPT)			
SIZE	PART NUMBER	WT	LIST PRICE
Standard Bituminous Coating			
1½	80010	7	\$124.88
2	80110	8	\$137.02
Fusion Bonded Coating			
1½	80010F	7	\$162.35
2	80110F	8	\$178.12

While Supplies last

May be configured for any size threaded branch up to maximum tap size shown, specify thread size required.

ACME SERVICE TEE				
				
(Female ACME Outlet)				
SIZE	PART NUMBER	WT	STYLE	LIST PRICE
Standard Bituminous Coating				
2 x 1½	8015303	6	B	\$90.18
2½ x 1½	8025303	7	B	\$90.18
3 x 1½	8035303	11	B	\$169.96
4 x 1½	8045303	13	B	\$192.51
6 x 1½	8065303	19	B	\$295.85
8 x 1½	8085303	33	B	\$519.97
Fusion Bonded Coating				
2 x 1½	8015303F	6	B	\$117.23
2½ x 1½	8025303F	7	B	\$117.23
3 x 1½	8035303F	11	B	\$220.95
4 x 1½	8045303F	13	B	\$250.26
6 x 1½	8065303F	19	B	\$384.60
8 x 1½	8085303F	33	B	\$675.96

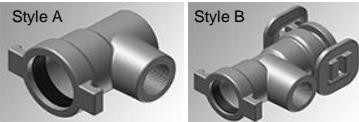
SIDE OUTLET TAPPED CAP				
				
(FNPT or Female ACME)				
SIZE	PART NUMBER	WT	STYLE	LIST PRICE
Standard Bituminous Coating				
2 x 1½	80168	12	B	\$156.00
2 x 1½ ACME	801683	12	B	\$156.00
2½ x 1½	80268	6	A	\$156.00
2½ x 1½ ACME	802683	6	A	\$156.00
Fusion Bonded Coating				
2 x 1½	80168F	12	B	\$202.80
2 x 1½ ACME	801683F	12	B	\$202.80
2½ x 1½	80268F	6	A	\$202.80
2½ x 1½ ACME	802683F	6	A	\$202.80

NOTE:

- 1½" - 12": Bells and spigots are IPS size unless noted otherwise.
- Figures are representative and may not reflect exact form.
- Ductile Iron MNPT & FNPT threads are not coated. Separate measures must be taken to protect NPT threads.

The HARCO Ductile Iron Fitting product line of easily connected modular components is covered by US Patent #5,183,298. Products in this price list are mostly import. A limited number of domestic configurations available.

Harco Fittings LLC Price List

Fittings

TAPPED TEE (Service Tee)			
(Female NPT Outlet)			
SIZE	PART NUMBER	WT	LIST PRICE
Standard Bituminous Coating			
1½ x 1	800502	8	\$163.17
1½ x 1½	800503	8	\$141.26
2 x 1	801502	7	\$83.25
2 x 1¼	8015025	6	\$86.02
2 x 1½	801503	6	\$76.36
2 x 2	801504	30	\$182.12
2½ x 1	802502	7	\$79.30
2½ x 1¼	8025025	7	\$83.25
2½ x 1½	802503	7	\$83.25
2½ x 2	802504	9	\$83.25
2½ x 2½	802505	15	\$206.39
3 x 1	803502	10	\$164.76
3 x 1¼	8035025	11	\$164.76
3 x 1½	803503	10	\$161.30
3 x 2	803504	9	\$161.30
3 x 2½	803505	11	\$164.76
3 x 3	803506	20	\$225.46
4 x 1	804502	14	\$189.04
4 x 1¼	8045025	14	\$189.04
4 x 1½	804503	13	\$189.04
4 x 2	804504	13	\$182.12
4 x 2½	804505	16	\$182.12
4 x 3	804506	16	\$182.12
6 x 1	806502	16	\$239.33
6 x 1¼	8065025	16	\$239.33
6 x 1½	806503	15	\$239.33
6 x 2	806504	16	\$239.33
6 x 2½	806505	22	\$239.33
6 x 3	806506	21	\$243.28

Some items use iron threaded bushings to accomplish smaller thread sizes. Size x Size items assembled from threaded tees and male adapters.

TAPPED TEE (Service Tee)			
(Female NPT Outlet)			
SIZE	PART NUMBER	WT	LIST PRICE
Fusion Bonded Coating			
1½ x 1	800502F	8	\$212.13
1½ x 1½	800503F	8	\$183.64
2 x 1	801502F	7	\$108.22
2 x 1¼	8015025F	6	\$111.83
2 x 1½	801503F	6	\$99.27
2 x 2	801504F	30	\$236.75
2½ x 1	802502F	7	\$103.09
2½ x 1¼	8025025F	7	\$108.22
2½ x 1½	802503F	7	\$108.22
2½ x 2	802504F	9	\$108.22
2½ x 2½	802505F	15	\$268.31
3 x 1	803502F	10	\$214.19
3 x 1¼	8035025F	11	\$214.19
3 x 1½	803503F	10	\$209.70
3 x 2	803504F	9	\$209.70
3 x 2½	803505F	11	\$214.19
3 x 3	803506F	20	\$293.09
4 x 1	804502F	14	\$245.75
4 x 1¼	8045025F	14	\$245.75
4 x 1½	804503F	13	\$245.75
4 x 2	804504F	13	\$236.75
4 x 2½	804505F	16	\$236.75
4 x 3	804506F	16	\$236.75
6 x 1	806502F	16	\$311.13
6 x 1¼	8065025F	16	\$311.13
6 x 1½	806503F	15	\$311.13
6 x 2	806504F	16	\$311.13
6 x 2½	806505F	22	\$311.13
6 x 3	806506F	21	\$316.26

Some items use iron threaded bushings to accomplish smaller thread sizes. Size x Size items assembled from threaded tees and male adapters.



NOTE:

- 1½" - 12": Bells and spigots are IPS size unless noted otherwise.
- Figures are representative and may not reflect exact form.
- Ductile Iron MNPT & FNPT threads are not coated. Separate measures must be taken to protect NPT threads.

The HARCO Ductile Iron Fitting product line of easily connected modular components is covered by US Patent #5,183,298. Products in this price list are mostly import. A limited number of domestic configurations available.



Harco Fittings LLC Price List

Fittings

TAPPED TEE (Service Tee) (continued) (Female NPT Outlet)			
			
		1 1/2 - 8"	10 - 16"
SIZE	PART NUMBER	WT	LIST PRICE
Standard Bituminous Coating			
8 x 1	808502	32	\$345.44
8 x 1 1/4	8085025	32	\$345.44
8 x 1 1/2	808503	32	\$345.44
8 x 2	808504	31	\$345.44
8 x 2 1/2	808505	31	\$345.44
8 x 3	808506	30	\$345.44
* 10 x 1	810502	66	\$696.39
* 10 x 1 1/4	8105025	66	\$696.39
* 10 x 1 1/2	810503	67	\$696.39
* 10 x 2	810504	66	\$696.39
* 10 x 2 1/2	810505	66	\$696.39
* 10 x 3	810506	66	\$696.39
* 12 x 1	812502	84	\$775.23
* 12 x 1 1/4	8125025	84	\$775.23
* 12 x 1 1/2	812503	85	\$775.23
* 12 x 2	812504	84	\$775.23
* 12 x 2 1/2	812505	84	\$775.23
* 12 x 3	812506	84	\$775.23
* 14 x 2	814504	158	\$2,099.71
* 14 x 2 1/2	814505	158	\$2,099.71
* 14 x 3	814506	158	\$2,099.71
* 16 x 2	816504	194	\$2,678.07
* 16 x 2 1/2	816505	194	\$2,678.07
* 16 x 3	816506	194	\$2,678.07

Some items use iron threaded bushings to accomplish smaller thread sizes. Size x Size items assembled from threaded tees and male adapters.

* Assembled with Swivel Tee and Swivel x Thread Adapter.

TAPPED TEE (Service Tee) (continued) (Female NPT Outlet)			
			
		1 1/2 - 8"	10 - 16"
SIZE	PART NUMBER	WT	LIST PRICE
Fusion Bonded Coating			
8 x 1	808502F	32	\$449.08
8 x 1 1/4	8085025F	32	\$449.08
8 x 1 1/2	808503F	32	\$449.08
8 x 2	808504F	31	\$449.08
8 x 2 1/2	808505F	31	\$449.08
8 x 3	808506F	30	\$449.08
* 10 x 1	810502F	66	\$905.30
* 10 x 1 1/4	8105025F	66	\$905.30
* 10 x 1 1/2	810503F	67	\$905.30
* 10 x 2	810504F	66	\$905.30
* 10 x 2 1/2	810505F	66	\$905.30
* 10 x 3	810506F	66	\$905.30
* 12 x 1	812502F	84	\$1,007.79
* 12 x 1 1/4	8125025F	84	\$1,007.79
* 12 x 1 1/2	812503F	85	\$1,007.79
* 12 x 2	812504F	84	\$1,007.79
* 12 x 2 1/2	812505F	84	\$1,007.79
* 12 x 3	812506F	84	\$1,007.79
* 14 x 2	814504F	158	\$2,099.71
* 14 x 2 1/2	814505F	158	\$2,099.71
* 14 x 3	814506F	158	\$2,099.71
* 16 x 2	816504F	194	\$2,678.07
* 16 x 2 1/2	816505F	194	\$2,678.07
* 16 x 3	816506F	194	\$2,678.07

Some items use iron threaded bushings to accomplish smaller thread sizes. Size x Size items assembled from threaded tees and male adapters.

* Assembled with Swivel Tee and Swivel x Thread Adapter.

NOTE:

- 1 1/2" - 12": Bells and spigots are IPS size unless noted otherwise.
- 14" - 16": Bells and spigots are DIPS size.
- Figures are representative and may not reflect exact form.
- Ductile Iron MNPT & FNPT threads are not coated. Separate measures must be taken to protect NPT threads.



The HARCO Ductile Iron Fitting product line of easily connected modular components is covered by US Patent #5,183,298. Products in this price list are mostly import. A limited number of domestic configurations available.

Harco Fittings LLC Price List

Fittings

PLUG			
(Solid x Spigot)			
SIZE	PART NUMBER	WT	LIST PRICE
Standard Bituminous Coating			
2	80155	5	\$71.12
2½	80255	6	\$74.59
3	80355	6	\$76.32
4	80455	12	\$91.92
6	80655	17	\$120.05
8	80855	20	\$135.28
10	81055	37	\$251.45
12	81255	51	\$367.38
Fusion Bonded Coating			
2	80155F	5	\$92.45
2½	80255F	6	\$96.97
3	80355F	6	\$99.21
4	80455F	12	\$119.49
6	80655F	17	\$156.07
8	80855F	20	\$175.86
10	81055F	37	\$326.88
12	81255F	51	\$477.59

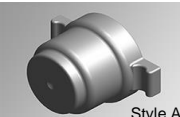
Two (2) links and two (2) wedges for each Plug are included in price and shipped automatically.

CAP				
				
SIZE	PART NUMBER	WT	STYLE	LIST PRICE
Standard Bituminous Coating				
1½	80066	4	A	\$215.86
2	80166	8	B	\$135.28
2½	80266	4	A	\$135.28
3	80366	17	B	\$185.58
4	80466	25	B	\$220.26
6	80666	40	B	\$319.40
8	80866	55	B	\$453.97
10	81066	97	B	\$856.87
12	81266	127	B	\$1,114.22
14	81466MJ	66	A	\$1,389.34
16	81666MJ	92	A	\$1,749.21
Fusion Bonded Coating				
1½	80066F	4	A	\$280.62
2	80166F	8	B	\$175.86
2½	80266F	4	A	\$175.86
3	80366F	17	B	\$241.26
4	80466F	25	B	\$286.34
6	80666F	40	B	\$415.21
8	80866F	55	B	\$590.16
10	81066F	97	B	\$1,113.93
12	81266F	127	B	\$1,448.49
14	81466MJFS	66	MJ	\$1,806.15
16	81666MJFS	92	MJ	\$2,273.97

MJ fittings include Standard Accessories

MJFS fittings include FBC Gland and SS hardware

NOTE:

- Fittings are Push Joint (PJ) unless denoted by "MJ" part number suffix as a Mechanical Joint.
- 1½" - 12": Bells and spigots are IPS size unless noted otherwise.
- 14" - 16": Bells and spigots are DIPS size.
- Figures are representative and may not reflect exact form.

The HARCO Ductile Iron Fitting product line of easily connected modular components is covered by US Patent #5,183,298. Products in this price list are mostly import. A limited number of domestic configurations available.

Harco Fittings LLC Price List

Fittings

TAPPED PLUG			
(Female NPT x Spigot)			
SIZE	PART NUMBER	WT	LIST PRICE
Standard Bituminous Coating			
2 x 1	8015602	5	\$95.39
2 x 1½	8015603	5	\$95.39
2½ x 1	8025602	6	\$97.13
2½ x 1½	8025603	6	\$97.13
2½ x 2	8025604	6	\$97.13
3 x 1	8035602	6	\$100.60
3 x 1½	8035603	6	\$100.60
3 x 2	8035604	6	\$100.60
3 x 2½	8035605	6	\$100.60
4 x 1½	8045603	12	\$114.46
4 x 2	8045604	12	\$114.46
4 x 2½	8045605	12	\$114.46
4 x 3	8045606	12	\$114.46
6 x 1½	8065603	16	\$167.81
6 x 2	8065604	16	\$167.81
6 x 2½	8065605	16	\$167.81
6 x 3	8065606	16	\$167.81
8 x 1½	8085603	20	\$211.30
8 x 2	8085604	20	\$211.30
8 x 2½	8085605	20	\$211.30
8 x 3	8085606	19	\$211.30
10 x 1½	8105603	37	\$352.69
10 x 2	8105604	36	\$352.69
10 x 2½	8105605	36	\$352.69
10 x 3	8105606	36	\$352.69
12 x 1½	8125603	51	\$519.71
12 x 2	8125604	51	\$519.71
12 x 2½	8125605	51	\$519.71
12 x 3	8125606	51	\$519.71

Two (2) links and two (2) wedges for each Tapped Plug are included in price and shipped automatically. Some items use iron threaded bushings to accomplish smaller thread sizes.

TAPPED PLUG			
(Female NPT x Spigot)			
SIZE	PART NUMBER	WT	LIST PRICE
Fusion Bonded Coating			
2 x 1	8015602F	5	\$124.01
2 x 1½	8015603F	5	\$124.01
2½ x 1	8025602F	6	\$126.27
2½ x 1½	8025603F	6	\$126.27
2½ x 2	8025604F	6	\$126.27
3 x 1	8035602F	6	\$130.77
3 x 1½	8035603F	6	\$130.77
3 x 2	8035604F	6	\$130.77
3 x 2½	8035605F	6	\$130.77
4 x 1½	8045603F	12	\$148.79
4 x 2	8045604F	12	\$148.79
4 x 2½	8045605F	12	\$148.79
4 x 3	8045606F	12	\$148.79
6 x 1½	8065603F	16	\$218.15
6 x 2	8065604F	16	\$218.15
6 x 2½	8065605F	16	\$218.15
6 x 3	8065606F	16	\$218.15
8 x 1½	8085603F	20	\$274.69
8 x 2	8085604F	20	\$274.69
8 x 2½	8085605F	20	\$274.69
8 x 3	8085606F	19	\$274.69
10 x 1½	8105603F	37	\$458.50
10 x 2	8105604F	36	\$458.50
10 x 2½	8105605F	36	\$458.50
10 x 3	8105606F	36	\$458.50
12 x 1½	8125603F	51	\$675.62
12 x 2	8125604F	51	\$675.62
12 x 2½	8125605F	51	\$675.62
12 x 3	8125606F	51	\$675.62

Two (2) links and two (2) wedges for each Tapped Plug are included in price and shipped automatically. Some items use iron threaded bushings to accomplish smaller thread sizes.

NOTE:

- 1½" - 12": Bells and spigots are IPS size unless noted otherwise.
- Figures are representative and may not reflect exact form.
- Ductile Iron MNPT & FNPT threads are not coated. Separate measures must be taken to protect NPT threads.

The HARCO Ductile Iron Fitting product line of easily connected modular components is covered by US Patent #5,183,298. Products in this price list are mostly import. A limited number of domestic configurations available.

Harco Fittings LLC Price List

Fittings

TAPPED CAP			
(Female NPT x Bell)			
SIZE	PART NUMBER	WT	LIST PRICE
Standard Bituminous Coating			
2 x 1	8016702	5	\$135.28
2 x 1½	8016703	5	\$135.28
2½ x 1	8026702	6	\$137.02
2½ x 1½	8026703	6	\$137.02
2½ x 2	8026704	6	\$137.02
3 x 1	8036702	6	\$189.04
3 x 1½	8036703	6	\$189.04
3 x 2	8036704	6	\$189.04
3 x 2½	8036705	6	\$189.04
4 x 1½	8046703	12	\$220.26
4 x 2	8046704	12	\$220.26
4 x 2½	8046705	12	\$220.26
4 x 3	8046706	12	\$220.26
6 x 1½	8066703	16	\$364.08
6 x 2	8066704	16	\$364.08
6 x 2½	8066705	16	\$364.08
6 x 3	8066706	16	\$364.08
8 x 1½	8086703	20	\$640.19
8 x 2	8086704	20	\$640.19
8 x 2½	8086705	20	\$640.19
8 x 3	8086706	19	\$640.19
10 x 1½	8106703	37	\$932.66
10 x 2	8106704	36	\$932.66
10 x 2½	8106705	36	\$932.66
10 x 3	8106706	36	\$932.66
12 x 1½	8126703	51	\$1,188.00
12 x 2	8126704	51	\$1,188.00
12 x 2½	8126705	51	\$1,188.00
12 x 3	8126706	51	\$1,188.00

Some items use iron threaded bushings to accomplish smaller thread sizes.

TAPPED CAP			
(Female NPT x Bell)			
SIZE	PART NUMBER	WT	LIST PRICE
Fusion Bonded Coating			
2 x 1	8016702F	5	\$175.86
2 x 1½	8016703F	5	\$175.86
2½ x 1	8026702F	6	\$178.12
2½ x 1½	8026703F	6	\$178.12
2½ x 2	8026704F	6	\$178.12
3 x 1	8036702F	6	\$245.75
3 x 1½	8036703F	6	\$245.75
3 x 2	8036704F	6	\$245.75
3 x 2½	8036705F	6	\$245.75
4 x 1½	8046703F	12	\$286.34
4 x 2	8046704F	12	\$286.34
4 x 2½	8046705F	12	\$286.34
4 x 3	8046706F	12	\$286.34
6 x 1½	8066703F	16	\$473.30
6 x 2	8066704F	16	\$473.30
6 x 2½	8066705F	16	\$473.30
6 x 3	8066706F	16	\$473.30
8 x 1½	8086703F	20	\$832.25
8 x 2	8086704F	20	\$832.25
8 x 2½	8086705F	20	\$832.25
8 x 3	8086706F	19	\$832.25
10 x 1½	8106703F	37	\$1,212.45
10 x 2	8106704F	36	\$1,212.45
10 x 2½	8106705F	36	\$1,212.45
10 x 3	8106706F	36	\$1,212.45
12 x 1½	8126703F	51	\$1,544.40
12 x 2	8126704F	51	\$1,544.40
12 x 2½	8126705F	51	\$1,544.40
12 x 3	8126706F	51	\$1,544.40

Some items use iron threaded bushings to accomplish smaller thread sizes.



NOTE:

- 1½" - 12": Bells and spigots are IPS size unless noted otherwise.
- Figures are representative and may not reflect exact form.
- Ductile Iron MNPT & FNPT threads are not coated. Separate measures must be taken to protect NPT threads.

The HARCO Ductile Iron Fitting product line of easily connected modular components is covered by US Patent #5,183,298. Products in this price list are mostly import. A limited number of domestic configurations available.

Harco Fittings LLC Price List

Fittings

FLANGE x BELL ADAPTER				
		 		
SIZE	PART NUMBER	WT	STYLE	LIST PRICE
Standard Bituminous Coating				
3 x 3	80360FB	22	A or B	\$263.62
3 x 4	80360-04	35	B	\$400.63
4 x 4	80460FB	29	A or B	\$300.04
4 x 6	80460-06	57	B	\$574.05
6 x 6	80660FB	47	A or B	\$463.06
6 x 8	80660-08	93	B	\$1,009.03
8 x 8	80860FB	67	A or B	\$528.97
8 x 10	80860-10	141	B	\$1,624.04
10 x 8	81060-08	99	B	\$1,383.97
10 x 10	81060FB	56	A or B	\$976.40
10 x 12	81060-12	216	B	\$2,006.60
12 x 10	81260-10	145	B	\$1,685.73
12 x 12	81260FB	76	A or B	\$1,194.92
Fusion Bonded Coating				
3 x 3	80360FBF	22	A or B	\$342.70
3 x 4	80360-04F	35	B	\$520.82
4 x 4	80460FBF	29	A or B	\$390.05
4 x 6	80460-06F	57	B	\$746.26
6 x 6	80660FBF	47	A or B	\$601.97
6 x 8	80660-08F	93	B	\$1,311.74
8 x 8	80860FBF	67	A or B	\$687.66
8 x 10	80860-10F	141	B	\$2,111.25
10 x 8	81060-08F	99	B	\$1,799.15
10 x 10	81060FBF	56	A or B	\$1,269.33
10 x 12	81060-12F	216	B	\$2,608.58
12 x 10	81260-10F	145	B	\$2,191.45
12 x 12	81260FBF	76	A or B	\$1,553.39

FLANGE OUTLET TEE			
			
(Bell x Bell x Flange)			
SIZE	PART NUMBER	WT	LIST PRICE
Standard Bituminous Coating			
3 x 3	80300F	27	\$357.26
4 x 4	80400F	39	\$426.64
6 x 4	80601F	49	\$584.46
6 x 6	80600F	62	\$695.45
8 x 6	80801F	76	\$893.16
8 x 8	80800F	94	\$1,175.57
10 x 6	81002F	111	\$1,200.12
10 x 8	81001F	130	\$1,264.30
10 x 10	81000F	180	\$2,063.79
12 x 6	81203F	128	\$1,452.57
12 x 8	81202F	145	\$1,703.46
12 x 12	81200F	240	\$2,715.63
Fusion Bonded Coating			
3 x 3	80300FF	27	\$446.58
4 x 4	80400FF	39	\$533.29
6 x 4	80601FF	49	\$730.57
6 x 6	80600FF	62	\$869.31
8 x 6	80801FF	76	\$1,116.43
8 x 8	80800FF	94	\$1,469.47
10 x 6	81002FF	111	\$1,500.15
10 x 8	81001FF	130	\$1,580.37
10 x 10	81000FF	180	\$2,579.74
12 x 6	81203FF	128	\$1,815.73
12 x 8	81202FF	145	\$2,129.33
12 x 12	81200FF	240	\$3,394.51

Items with Style noted as "A or B" may be shipped either way at HARCO's option

NOTE:

- 1½" - 12": Bells and spigots are IPS size unless noted otherwise.
- Flange bolt pattern is compatible with 125 and 150 Class flanges.
- Figures are representative and may not reflect exact form.

The HARCO Ductile Iron Fitting product line of easily connected modular components is covered by US Patent #5,183,298.

Products in this price list are mostly import. A limited number of domestic configurations available.

Harco Fittings LLC • P.O. Box 10335 • Lynchburg, Virginia 24506-0335

PHONE: 434-845-7094 • FAX: 434-845-8562 • E-MAIL: sales@harcofittings.com • WEB: www.harcofittings.com

Harco Fittings LLC Price List

Fittings

FLANGE ACCESSORIES



(For Class 125 & 150)

SIZE	PART NUMBER	WT	LIST PRICE
3	856031	2	\$29.26
4	856041	4	\$46.55
6	856061	6	\$74.23
8	856081	6	\$81.25
10	856101	13	\$105.80
12	856121	14	\$168.92
14	856141	15	\$290.35
16	856161	26	\$329.81

Each kit contains 1/8" red rubber full face gasket and zinc plated ASTM A307 Grade B bolts and nuts.

Call for other gasket materials.

FLANGE ACCESSORIES

316 SS Bolts



(For Class 125 & 150)

SIZE	PART NUMBER	WT	LIST PRICE
3	856031S	2	\$153.53
4	856041S	4	\$248.90
6	856061S	6	\$421.80
8	856081S	6	\$439.31
10	856101S	13	\$802.10
12	856121S	14	\$897.56
14	856141S	15	\$377.45
16	856161S	26	\$428.76

Each kit contains 1/8" red rubber full face gasket. Separately applied lubricant should be used during torquing to prevent galling.

NOTE:

- 1½" - 12": Bells and spigots are IPS size unless noted otherwise.
- Flange bolt pattern is compatible with 125 and 150 Class flanges.
- Figures are representative and may not reflect exact form.

SPIGOT x FLANGE ADAPTER

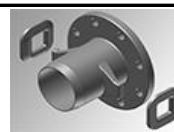

SIZE	PART NUMBER	WT	LIST PRICE
Standard Bituminous Coating			
3	80360	13	\$164.76
4	80460	17	\$195.99
6	80660	24	\$282.69
8	80860	33	\$326.05
10	81060	71	\$650.36
12	81260	94	\$685.05
Fusion Bonded Coating			
3	80360F	13	\$214.19
4	80460F	17	\$254.78
6	80660F	24	\$367.50
8	80860F	33	\$423.87
10	81060F	71	\$845.47
12	81260F	94	\$890.56

Two (2) links and two (2) wedges for each Spigot x Flange Adapter are included in price and shipped automatically.

MALE ADAPTER

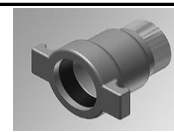

(Bell x Male NPT)

SIZE	PART NUMBER	WT	LIST PRICE
Standard Bituminous Coating			
1½ x 1½	80070	3	\$65.89
2 x 1½	80172	3	\$71.12
2 x 2	80170	4	\$71.12
2½ x 2	80272	3	\$81.51
2½ x 2½	80270	5	\$81.51
3 x 3	80370	6	\$97.13
4 x 4	80470	8	\$114.46
Fusion Bonded Coating			
1½ x 1½	80070F	3	\$85.66
2 x 1½	80172F	3	\$92.45
2 x 2	80170F	4	\$92.45
2½ x 2	80272F	3	\$105.96
2½ x 2½	80270F	5	\$105.96
3 x 3	80370F	6	\$126.27
4 x 4	80470F	8	\$148.79

The HARCO Ductile Iron Fitting product line of easily connected modular components is covered by US Patent #5,183,298. Products in this price list are mostly import. A limited number of domestic configurations available.

Harco Fittings LLC Price List

Fittings

REPLACEMENT GASKET			
			
(SBR)			
SIZE	PART NUMBER	WT	LIST PRICE
1½	851015	0.1	\$10.29
2	85102	0.1	\$10.01
2½	851025	0.1	\$11.44
3	85103	0.1	\$12.86
4	85504	0.2	\$17.15
6	85506	0.4	\$23.50
8	85508	0.7	\$27.90
10	85510	1.2	\$45.09
12	85512	1.8	\$54.33

Call for other gasket materials.

PUSH JOINT GASKET			
			
(SBR)			
SIZE	PART NUMBER	WT	LIST PRICE
14	85514	2.5	\$153.30
16	85516	2.9	\$202.07

Call for other gasket materials.

MECHANICAL JOINT GASKET			
			
(SBR)			
SIZE	PART NUMBER	WT	LIST PRICE
14	40114	1.3	\$118.82
16	40116	1.4	\$137.18

Call for other gasket materials.

MJ ACCESSORY KIT			
			
SIZE	PART NUMBER	WT	LIST PRICE
14	GLAND-PACK-14	21.6	\$386.61
16	GLAND-PACK-16	7.3	\$414.19

Includes Gland, Gasket, T-bolts and Nuts.

MJ ACCESSORY KIT			
			
(316 SS Bolts)			
SIZE	PART NUMBER	WT	LIST PRICE
14	GLAND-PACK-14S	21.6	\$502.59
16	GLAND-PACK-16S	7.3	\$538.45

Includes Gland, Gasket, T-bolts and Nuts.

NOTE:

- Figures are representative and may not reflect exact form.

The HARCO Ductile Iron Fitting product line of easily connected modular components is covered by US Patent #5,183,298. Products in this price list are mostly import. A limited number of domestic configurations available.

Harco Fittings LLC Price List

Fittings

LINKS			
			
1 1/2 - 8" 10 - 12" Transition			
SIZE	PART NUMBER	WT	LIST PRICE
Standard Bituminous Coating			
1 1/2 - 8	82000	1	\$18.58
10 - 12	82003	3.6	\$62.25
* 10-12 Transition	82004	1.4	\$22.53
Fusion Bonded Coating			
1 1/2 - 8	82000F	1	\$24.15
10 - 12	82003F	3.6	\$80.92
* 10-12 Transition	82004F	1.4	\$29.29

Links included in price of and automatically shipped with S.E.B.s, flange adapters, and plugs.

* Used to assemble old style lug to new style thicker lug

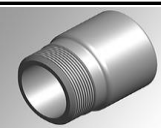
ACME ADAPTER			
			
(Male NPT x Female ACME)			
SIZE	PART NUMBER	WT	LIST PRICE
Standard Bituminous Coating			
2 x 1 1/2	872-206	2	\$63.14
Fusion Bonded Coating			
2 x 1 1/2	872-206F	2	\$82.08

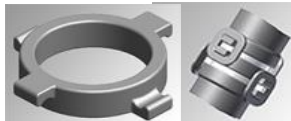
CROSSOVER RING			
			
SIZE	PART NUMBER	WT	LIST PRICE
Standard Bituminous Coating			
3	82103	3	\$64.17
4	82104	4	\$64.17
6	82106	8	\$83.25
Fusion Bonded Coating			
3	82103F	3	\$83.43
4	82104F	4	\$83.43
6	82106F	8	\$108.22

While supplies last

Designed to rotate "lug" axis 90°. Links sold separately.

POLYETHYLENE ENCASEMENT			
			
(For use in corrosive soils)			
SIZE	PART NUMBER	WT	LIST PRICE
20 x 400	82320	34	\$907.31
30 x 200	82330	28	\$711.33
37 x 200	82337	35	\$841.98
2 x 100 Tape	823PT	1	\$36.31

Polyethylene encasement supplied in rolls in tubular form, 8 mils thick. 20" for fittings up to 8", 30" for fittings 10" to 14", and 37" for fittings 16" to 20". Complies with AWWA C105.

For installation, refer to Ductile Iron Pipe Research Association's Corrosion Control Polyethylene Encasement publication at www.dipra.org.

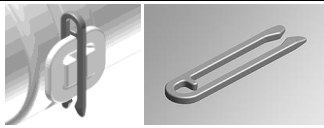
RETAINER CLIP			
			
SIZE	WT	LIST PRICE	
82009	0.3	\$5.21	

Alternative to wood wedge used when linking fittings together.

NOTE:

- Figures are representative and may not reflect exact form.
- Ductile Iron MNPT & FNPT threads are not coated. Separate measures must be taken to protect NPT threads.

The HARCO Ductile Iron Fitting product line of easily connected modular components is covered by US Patent #5,183,298. Products in this price list are mostly import. A limited number of domestic configurations available.

Harco Fittings LLC Price List

Saddles

SADDLE			
(Female NPT, 304 SS strap)			
SIZE	PART NUMBER	WT	LIST PRICE
Fusion Bonded Coating			
* 3 x 1	803802	5	\$125.39
* 3 x 1½	803803	5	\$125.39
3 x 2	803804	4	\$105.83
3 x 2½	803805	4	\$131.91
* 4 x 1	804802	5	\$125.39
* 4 x 1½	804803	5	\$125.39
4 x 2	804804	5	\$105.83
4 x 2½	804805	4	\$131.91
* 6 x 1	806802	6	\$134.63
* 6 x 1½	806803	6	\$134.63
6 x 2	806804	5	\$115.06
6 x 2½	806805	5	\$141.15
* 8 x 1	808802	7	\$141.88
* 8 x 1½	808803	7	\$141.88
8 x 2	808804	6	\$122.32
8 x 2½	808805	6	\$148.40
* 10 x 1½	810803	8	\$204.72
10 x 2	810804	6	\$185.15
10 x 2½	810805	6	\$211.24
* 12 x 1½	812803	8	\$213.62
12 x 2	812804	7	\$194.06
12 x 2½	812805	7	\$220.14

* Produced using 2" FNPT with 2" x 1½" or 2" x 1" Ductile Iron Bushing.

Bolt torque: 30-40 ft-lbs.

NOTE:

- Ductile Iron MNPT & FNPT threads are not coated. Separate measures must be taken to protect NPT threads.
- Figures are representative and may not reflect exact form.

Harco Fittings LLC Price List

Saddles

SADDLE, DOUBLE STRAP			
For IPS PVC & PE			
(Female NPT, 304 SS straps)			
SIZE	PART NUMBER	WT	LIST PRICE
Standard Shop Coating			
2 x 1	80180H2	4	\$180.36
2½ x 1	80280H2	5	\$183.10
3 x 2	80380H4	7	\$223.11
4 x 2	80480H4	10	\$232.94
6 x 2	80680H4	10	\$250.86
8 x 2	80880H4	12	\$315.21
10 x 2	81080H4	14	\$368.93
12 x 2	81280H4	16	\$418.62
* 14 x 2	81480H4	15	\$517.78
* 16 x 2	81680H4	16	\$521.70
Fusion Plastic Coating			
2 x 1	80180H2FPC	4	\$234.46
2½ x 1	80280H2FPC	5	\$238.03
3 x 2	80380HFPC	7	\$290.04
4 x 2	80480HFPC	10	\$302.82
6 x 2	80680HFPC	10	\$326.11
8 x 2	80880HFPC	12	\$409.77
10 x 2	81080HFPC	14	\$479.61
12 x 2	81280HFPC	16	\$544.21
* 14 x 2	81480HFPC	15	\$673.11
* 16 x 2	81680HFPC	16	\$678.21

* For IPS HDPE pipe only.

SDR 35 maximum when used on HDPE pipe. Other outlet sizes available. Allow 2 weeks for Fusion Plastic Coating.

Bolt torque:

2½" and smaller 15-20 ft-lbs

3" and larger 45-50 ft-lbs; see installation instructions.

SADDLE, DOUBLE STRAP			
For C900 PVC & DIPS PE			
(Female NPT)			
SIZE	PART NUMBER	WT	LIST PRICE
Standard Shop Coating			
4 x 2	80490H4	10	\$284.77
6 x 2	80690H4	10	\$304.31
8 x 2	80890H4	12	\$378.25
10 x 2	81090H4	14	\$442.72
12 x 2	81290H4	16	\$502.35
14 x 2	81490H4	15	\$616.18
16 x 2	81690H4	16	\$626.04
Fusion Plastic Coating			
4 x 2	80490HFPC	10	\$370.20
6 x 2	80690HFPC	10	\$395.60
8 x 2	80890HFPC	12	\$491.73
10 x 2	81090HFPC	14	\$575.54
12 x 2	81290HFPC	16	\$653.05
14 x 2	81490HFPC	15	\$801.03
16 x 2	81690HFPC	16	\$813.85

SDR 35 maximum when used on HDPE pipe. Other outlet sizes available.

Bolt torque: 45-50 ft-lbs; see installation instructions.

NOTE:

- Ductile Iron MNPT & FNPT threads are not coated. Separate measures must be taken to protect NPT threads.
- Figures are representative and may not reflect exact form.

Harco Fittings LLC • P.O. Box 10335 • Lynchburg, Virginia 24506-0335

PHONE: 434-845-7094 • FAX: 434-845-8562 • E-MAIL: sales@harcofittings.com • WEB: www.harcofittings.com

Harco Fittings LLC Price List

Lateral Isolation Valves

U.S. Patent #7,055,865; #7,552,949

FULL PORT VALVE, 316 SS			
Cross Handle with SS Grip Ring			
			
(Male Swivel x Gasket)			
SIZE x RISE	PART NUMBER	WT	LIST PRICE
2 x 6	8411062PQ	15	\$482.80
* 2 x 12	8411122PQ	18	\$574.46
2½ x 6	8412062PQ	15	\$687.93
3 x 6	8413062PQ	15.2	\$703.37
4 x 6	8414062PQ	28.8	\$869.33

* 2" x 12" valves are assembled from 2" x 6" valves and Fusion Bond coated 6" swivel extensions.

FULL PORT VALVE, 316 SS			
2" Square Nut with SS Grip Ring			
			
(Male Swivel x Gasket)			
SIZE x RISE	PART NUMBER	WT	LIST PRICE
2 x 6	8411062PR	15	\$498.72
* 2 x 12	8411122PR	18	\$616.12
2½ x 6	8412062PR	15	\$749.69
3 x 6	8413062PR	15.2	\$731.59
4 x 6	8414062PR	28.8	\$867.66

* 2" x 12" valves are assembled from 2" x 6" valves and Fusion Bond coated 6" swivel extensions.

Valves will be supplied with DI operating nut while supplies last. As valves with DI operating nuts are depleted, valves will be supplied with SS operating nuts. In this transition period it will be possible to receive valves with both styles of operating nut.

NOTE: "PL" & "PN" versions of the Lateral Isolation Valve w/ Ductile Iron Grip Ring have been discontinued.

FULL PORT VALVE, 316 SS			
Cross Handle with SS Grip Ring			
			
(Gasket x Gasket)			
SIZE	PART NUMBER	WT	LIST PRICE
3	8413GGPQ	16	\$717.05

FULL PORT VALVE, 316 SS			
2" Square Nut with SS Grip Ring			
			
(Gasket x Gasket)			
SIZE	PART NUMBER	WT	LIST PRICE
3	8413GGPR	16	\$748.54

STANDARD PORT VALVE 316 SS			
Cross Handle with SS Grip Ring			
			
(Male Swivel x Gasket)			
SIZE x RISE	PART NUMBER	WT	LIST PRICE
2 x 6	843106SQ	9.8	\$435.17
* 2 x 12	843112SQ	9.8	\$511.51

* 2" x 12" valves are assembled from 2" x 6" valves and Fusion Bond coated 6" swivel extensions.

STANDARD PORT VALVE, 316 SS			
Cross Handle with SS Grip Ring			
			
(Gasket x Gasket)			
SIZE	PART NUMBER	WT	LIST PRICE
2	8431GGSQ	10	\$483.42

SWIVEL EXTENSION with 1" SIDE OUTLET			
(Male Swivel x Female Swivel)			
			
RISE	PART NUMBER	WT	LIST PRICE
1" Side Outlet			
4	87106SOF	6	\$99.13
1" Side Outlet Plugged			
4	87106SOPF	6	\$115.35

SWIVEL EXTENSION, 316 SS with 1" SIDE OUTLET			
(Male Swivel x Female Swivel)			
			
RISE	PART NUMBER	WT	LIST PRICE
1" Side Outlet			
4	87106SOS	6	\$333.25
1" Side Outlet Plugged			
4	87106SOPS	6	\$348.44

Grip ring bolt torque: 35 ft-lbs

Harco Fittings LLC Price List

Lateral Isolation Valve Parts

LIV CROSS HANDLE			
			
DESCRIPTION	PART NUMBER	WT	LIST PRICE
Cross Handle	841-01	0.3	\$69.59

LIV SQUARE OPERATING NUT			
			
(For Full Port valves)			
DESCRIPTION	PART NUMBER	WT	LIST PRICE
Square Nut	841-12	1.8	\$29.82

LIV BONNET ASSEMBLY			
			
Full Port			
SIZE	PART NUMBER	WT	LIST PRICE
2 - 4 w/ Cross Handle	841-03	5	\$327.77
2 - 4 w/ Square Nut	841-03N	5	\$357.59

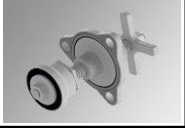
LIV BONNET ASSEMBLY			
			
Standard Port			
SIZE	PART NUMBER	WT	LIST PRICE
2	841-04	9	\$228.95

Call for replacement bonnet assemblies for previous generation 3" & 4" full port ductile iron, Lateral Isolation Valves, Part# 8413-03 while supplies last.

GASKET			
			
SIZE	PART NUMBER	WT	LIST PRICE
2	85102	0.1	\$10.01
2½	851025	0.1	\$11.44
3	85103	0.1	\$12.86
4	85504	0.2	\$17.15

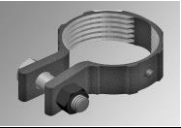
GRIP RING ASSEMBLY			
			
DI Grip Ring			
SIZE	PART NUMBER	WT	LIST PRICE
2	8411-04	0.8	\$55.15
2½	8412-04	0.8	\$59.91
3	8413-04	0.9	\$69.26
4	8414-04	0.9	\$73.18

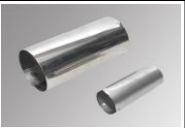
PE PIPE STIFFENER				
				
(For Lateral Isolation Valve)				
SIZE	SDR	PART NUMBER	WT	LIST PRICE
2	9	65-90480902	0.2	\$27.12
	11	65-90481102	0.2	\$27.12
	13.5	65-90481302	0.2	\$27.12
	15.5	65-90481502	0.2	\$27.12
	17	65-90481702	0.2	\$27.12
3	9	65-90480903	0.3	\$45.56
	11	65-90481103	0.3	\$45.56
	13.5	65-90481303	0.3	\$45.56
	15.5	65-90481503	0.3	\$45.56
	17	65-90481703	0.3	\$45.56
4	9	65-90480904	0.3	\$76.60
	11	65-90481104	0.3	\$76.60
	13.5	65-90481304	0.3	\$76.60
	15.5	65-90481504	0.3	\$76.60
	17	65-90481704	0.3	\$76.60

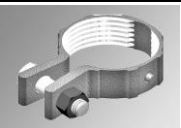
GRIP RING ASSEMBLY			
			
SS Grip Ring			
SIZE	PART NUMBER	WT	LIST PRICE
1½	8410-04S	0.7	\$66.79
2	8411-04S	0.7	\$66.57
2½	8412-04S	0.8	\$72.04
3	8413-04S	0.9	\$78.50
4	8414-04S	1.3	\$106.07

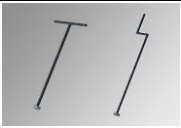
VALVE OPERATING KEYS		
		
Heavy Duty		
(For HARCO LIV's w/ X-Handle or Op Nut)		
DESCRIPTION	PART NUMBER	LIST PRICE
T-Handle	841-60T	\$248.52
Crank Handle	841-60L	\$248.52

Harco Fittings LLC Price List

Swivel Joint Lateral Connection System

U.S. Patent #7,055,865

SWIVEL TEE			
			
(Female Swivel Outlet)			
SIZE	PART NUMBER	WT	LIST PRICE
Standard Bituminous Coating			
2	8015405	23	\$113.18
2½	8025405	10	\$113.18
3	8035405	12	\$169.96
4	8045405	16	\$194.24
6	8065405	26	\$253.20
8	8085405	35	\$362.47
10	8105405	62	\$723.21
12	8125405	79	\$822.04
* 14	8145405	153	\$1,477.60
* 16	8165405	189	\$1,909.44
Fusion Bonded Coating			
2	8015405F	23	\$147.13
2½	8025405F	10	\$147.13
3	8035405F	12	\$220.95
4	8045405F	16	\$252.51
6	8065405F	26	\$329.16
8	8085405F	35	\$471.21
10	8105405F	62	\$940.17
12	8125405F	79	\$1,068.65
* 14	8145405F	153	\$1,920.88
* 16	8165405F	189	\$2,482.27

* 14" & 16" are for C900 PVC pipe.

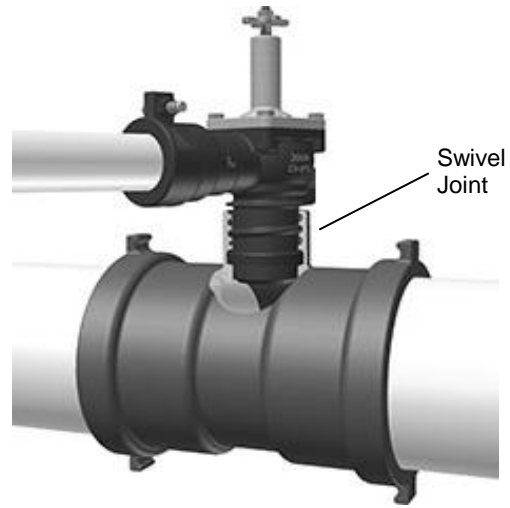

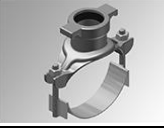
SADDLE			
			
(2" Gasketed Bell Outlet, 304SS Straps)			
SIZE	PART NUMBER	WT	LIST PRICE
Fusion Bonded Coating			
4	80482	5	\$112.74
6	80682	6	\$133.55
8	80882	6	\$147.42
10	81082	7	\$150.89
12	81282	8	\$161.30

While supplies last

Bolt torque: 30-40 ft-lbs; see installation instructions.

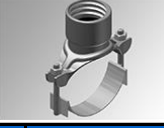
SADDLE			
			
(Female Swivel Outlet, 304SS Straps)			
SIZE	PART NUMBER	WT	LIST PRICE
Fusion Bonded Coating			
* 3	80381	7	\$182.40
4	80481	6	\$135.28
6	80681	7	\$150.04
8	80881	7	\$159.27
10	81081	8	\$168.92
12	81281	9	\$180.30

* Assembled from Service Saddle & Male Adapter

Swivel Saddles come with Fusion Bonded Coating standard.

FBC bolt torque: 40-50 ft-lbs; see installation instructions.

Harco Fittings LLC's standard Swivel System utilizes one unique size for the female to male swivel joint connection. All swivel male parts, regardless of functional size, fit all female swivel outlets of Swivel Tees and Swivel Saddles.

Harco Fittings LLC Price List

Swivel Joint Lateral Connection System

U.S. Patent #7,055,865

SADDLE, DOUBLE STRAP			
For IPS PVC & PE			
(Female Swivel Outlet, 304SS Straps)			
SIZE	PART NUMBER	WT	LIST PRICE
Standard Shop Coating			
3	80381H	11	\$307.16
4	80481H	14	\$316.99
6	80681H	14	\$334.91
8	80881H	16	\$399.27
10	81081H	18	\$452.99
12	81281H	20	\$502.68
* 14	81481H	19	\$601.83
* 16	81681H	19	\$605.76
Fusion Plastic Coating			
3	80381HFPC	11	\$399.31
4	80481HFPC	14	\$412.09
6	80681HFPC	14	\$435.39
8	80881HFPC	16	\$519.05
10	81081HFPC	18	\$588.89
12	81281HFPC	20	\$653.48
* 14	81481HFPC	19	\$782.38
* 16	81681HFPC	19	\$787.48



SADDLE, DOUBLE STRAP			
For C900 PVC & DIPS PE			
(Female Swivel Outlet, 304SS Straps)			
SIZE	PART NUMBER	WT	LIST PRICE
Standard Shop Coating			
4	80491H	14	\$368.83
6	80691H	14	\$388.36
8	80891H	16	\$462.31
10	81091H	18	\$526.78
12	81291H	20	\$586.40
14	81491H	19	\$700.24
16	81691H	19	\$710.10
Fusion Plastic Coating			
4	80491HFPC	14	\$479.47
6	80691HFPC	14	\$504.87
8	80891HFPC	16	\$601.00
10	81091HFPC	18	\$684.81
12	81291HFPC	20	\$762.32
14	81491HFPC	19	\$910.31
16	81691HFPC	19	\$923.13



* These are for IPS diameter.

SDR-35 maximum when used on HDPE pipe.

Bolt torque: 45-50 ft-lbs; see installation instructions.

Allow 2 weeks for Fusion Plastic Coating.

SDR-35 maximum when used on HDPE pipe.

Bolt torque: 45-50 ft-lbs; see installation instructions.

Allow 2 weeks for Fusion Plastic Coating.

SWIVEL EXTENSION			
(Male Swivel x Female Swivel)			
RISE	PART NUMBER	WT	LIST PRICE
Standard Bituminous Coating			
6	87106	6	\$50.30
12	87112	11	\$81.51
Fusion Bonded Coating			
6	87106F	6	\$65.39
12	87112F	11	\$105.96

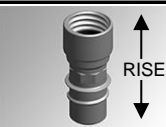

LATERAL 90°			
(Spigot / Groove x Male NPT)			
RISE	PART NUMBER	WT	LIST PRICE
Standard Bituminous Coating			
2	801884	6	\$115.04
3	803884	8	CALL
Fusion Bonded Coating			
2	801884F	6	\$149.55
3	803884F	8	CALL

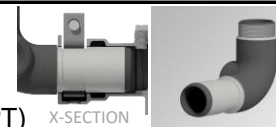

Harco Fittings LLC's standard Swivel System utilizes one unique size for the female to male swivel joint connection. All swivel male parts, regardless of functional size, fit all female swivel outlets of Swivel Tees and Swivel Saddles.

Harco Fittings LLC Price List

Swivel Joint Lateral Connection System

U.S. Patent #7,055,865

ADAPTER			
		X-SECTION	
(Spigot/Groove x Male NPT)			
SIZE	PART NUMBER	WT	LIST PRICE
Standard Bituminous Coating			
1½ x 6	8740606	3	\$62.23
2 x 4	8740408	2	\$62.23
2 x 6	8740608	3	\$69.75
2 x 8	8740808	5	\$77.30
2½ x 6	8740610	4	\$73.52
3 x 6	8740612	5	\$81.06
Fusion Bonded Coating			
1½ x 6	8740606F	3	\$80.90
2 x 4	8740408F	2	\$80.90
2 x 6	8740608F	3	\$90.68
2 x 8	8740808F	5	\$100.49
2½ x 6	8740610F	4	\$95.58
3 x 6	8740612F	5	\$105.38

Indicated length is the approximate distance from the face of the knuckle to the end of the thread.
Part has groove on spigot end for restraint to HARCO Bell with Knuckle Restraint. Call for other sizes and lengths. Also available in Spigot x Spigot. (Knuckles sold separately)

ADAPTER (COMPACT)			
		X-SECTION	
(Spigot x Male NPT)			
SIZE	PART NUMBER	WT	LIST PRICE
Standard Bituminous Coating			
2 x 1	874030804	3	\$60.32
2 x 1¼	874030805	3	\$60.32
2 x 1½	874030806	3	\$60.32
2 x 2	874030808	3	\$60.32
2 x 2½	874030810	3	\$65.80
Fusion Bonded Coating			
2 x 1	874030804F	3	\$78.42
2 x 1¼	874030805F	3	\$78.42
2 x 1½	874030806F	3	\$78.42
2 x 2	874030808F	3	\$78.42
2 x 2½	874030810F	3	\$85.54

Part has groove on spigot end for restraint to HARCO bell with Knuckle Restraint. (Knuckles sold separately)

ADAPTER			
			
(Female Swivel x MNPT)			
SIZE	PART NUMBER	WT	LIST PRICE
Standard Bituminous Coating			
2	873-008	3	\$104.06
Fusion Bonded Coating			
2	873-008F	3	\$135.28

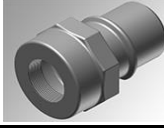
ADAPTER			
			
(Female NPT x Male Swivel)			
SIZE	PART NUMBER	WT	LIST PRICE
Standard Bituminous Coating			
1½	875-025-06	6	\$90.18
2	875-025-08	5	\$90.18
2½	875-025-10	5	\$90.18
3	875-025-12	4	\$90.18
Fusion Bonded Coating			
1½	875-025-06F	6	\$117.23
2	875-025-08F	5	\$117.23
2½	875-025-10F	5	\$117.23
3	875-025-12F	4	\$117.23

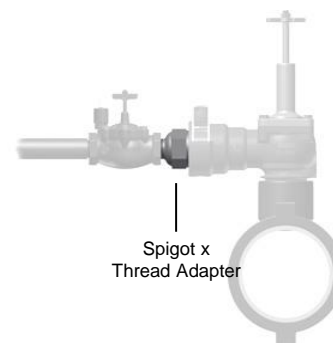

Harco Fittings LLC's standard Swivel System utilizes one unique size for the female to male swivel joint connection. All swivel male parts, regardless of functional size, fit all female swivel outlets of Swivel Tees and Swivel Saddles.

Harco Fittings LLC Price List

Swivel Joint Lateral Connection System

U.S. Patent #7,055,865

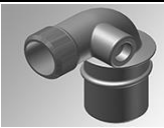
LATERAL 90°			
			
(Male NPT x Male Swivel)			
SIZE x RISE	PART NUMBER	WT	LIST PRICE
Standard Bituminous Coating			
Standard			
1 x 6	80B86	4	\$86.71
1½ x 6	80086	4	\$86.71
2 x 6	80186	5	\$90.48
* 2 x 12	8018612	7	\$120.65
2½ x 6	80286	5	\$98.03
3 x 7	80386	6	\$103.69
1" Side Outlet			
1 x 6	80B862	4	\$92.38
1½ x 6	800862	4	\$92.38
2 x 6	801862	5	\$98.03
* 2 x 12	80186122	7	\$128.19
2½ x 6	802862	5	\$105.57
3 x 7	803862	6	\$109.33
1" Side Outlet Plugged			
1 x 6	80B862P	4	\$98.03
1½ x 6	800862P	4	\$98.03
2 x 6	801862P	5	\$103.69
2½ x 6	802862P	5	\$109.33
3 x 7	803862P	6	\$114.99

* While supplies last

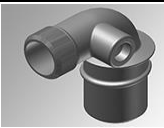
LATERAL 90°			
			
(Male NPT x Male Swivel)			
SIZE x RISE	PART NUMBER	WT	LIST PRICE
Fusion Bonded Coating			
Standard			
1 x 6	80B86F	4	\$112.73
1½ x 6	80086F	4	\$112.73
2 x 6	80186F	5	\$117.62
2½ x 6	80286F	5	\$127.44
3 x 7	80386F	6	\$134.79
1" Side Outlet			
1 x 6	80B862F	4	\$120.09
1½ x 6	800862F	4	\$120.09
2 x 6	801862F	5	\$127.44
2½ x 6	802862F	5	\$137.24
3 x 7	803862F	6	\$142.13
1" Side Outlet Plugged			
1 x 6	80B862PF	4	\$127.44
1½ x 6	800862PF	4	\$127.44
2 x 6	801862PF	5	\$134.79
2½ x 6	802862PF	5	\$142.13
3 x 7	803862PF	6	\$149.49

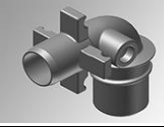
LATERAL 90°			
			
(Spigot x Male Swivel)			
SIZE x RISE	PART NUMBER	WT	LIST PRICE
Standard Bituminous Coating			
Standard			
2 x 6	8018506	6	\$74.65
2½ x 6	8028506	7	\$97.27
3 x 7	8038507	8	\$108.58
1" Side Outlet			
2 x 6	80185062	6	\$85.97
2½ x 6	80285062	7	\$106.33
3 x 7	80385072	8	\$117.63
1" Side Outlet Plugged			
2 x 6	80185062P	6	\$90.48
2½ x 6	80285062P	7	\$110.85
3 x 7	80385072P	8	\$124.41

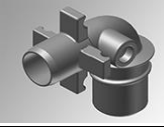
LATERAL 90°			
			
(Spigot x Male Swivel)			
SIZE x RISE	PART NUMBER	WT	LIST PRICE
Fusion Bonded Coating			
Standard			
2 x 6	8018506F	6	\$97.04
2½ x 6	8028506F	7	\$126.45
3 x 7	8038507F	8	\$141.16
1" Side Outlet			
2 x 6	80185062F	6	\$111.75
2½ x 6	80285062F	7	\$138.22
3 x 7	80385072F	8	\$152.92
1" Side Outlet Plugged			
2 x 6	80185062PF	6	\$117.62
2½ x 6	80285062PF	7	\$144.10
3 x 7	80385072PF	8	\$161.73

Harco Fittings LLC Price List

Swivel Joint Lateral Connection System

U.S. Patent #7,055,865

LATERAL NIPPLE			
			
(Male NPT x Male Swivel)			
SIZE x RISE	PART NUMBER	WT	LIST PRICE
Standard Bituminous Coating			
Standard			
2 x 8	8720808	4	\$63.33
2 x 12	8721208	6	\$68.76
2 x 18	8721808	8	\$99.53
2½ x 8	8720810	4	\$70.58
3 x 10	8721012	5	\$79.63
1" Side Outlet			
2 x 8	87208082	4	\$70.58
2 x 12	87212082	6	\$74.20
2 x 18	87218082	8	\$104.96
2½ x 8	87208102	4	\$77.81
3 x 10	87210122	5	\$86.88

LATERAL NIPPLE			
			
(Male NPT x Male Swivel)			
SIZE x RISE	PART NUMBER	WT	LIST PRICE
Fusion Bonded Coating			
Standard			
2 x 8	8720808F	4	\$82.33
2 x 12	8721208F	6	\$89.39
2 x 18	8721808F	8	\$129.39
2½ x 8	8720810F	4	\$91.75
3 x 10	8721012F	5	\$103.52
1" Side Outlet			
2 x 8	87208082F	4	\$91.75
2 x 12	87212082F	6	\$96.45
2 x 18	87218082F	8	\$136.45
2½ x 8	87208102F	4	\$101.16
3 x 10	87210122F	5	\$112.94

LATERAL NIPPLE			
			
(Spigot x Male Swivel)			
SIZE x RISE	PART NUMBER	WT	LIST PRICE
Standard Bituminous Coating			
Standard			
2 x 10	8731008	4	\$39.81
1" Side Outlet			
2 x 10	87310082	4	\$47.06

While supplies last

LATERAL NIPPLE			
			
(Spigot x Male Swivel)			
SIZE x RISE	PART NUMBER	WT	LIST PRICE
Fusion Bonded Coating			
Standard			
2 x 10	8731008F	4	\$51.75
1" Side Outlet			
2 x 10	87310082F	4	\$61.18

While supplies last

LATERAL TEE			
			
(Bell x Male Swivel)			
SIZE	PART NUMBER	WT	LIST PRICE
Standard Bituminous Coating			
2 x 6	80191	16	\$233.75
2½ x 6	80291	18	\$256.37
3 x 7	80391	24	\$269.58
Fusion Bonded Coating			
2 x 6	80191F	16	\$303.88
2½ x 6	80291F	18	\$333.28
3 x 7	80391F	24	\$350.45

Alternate configurations may be supplied. (Swivel Tee not included)

LATERAL 90°			
			
(Bell x Male Swivel)			
SIZE	PART NUMBER	WT	LIST PRICE
Standard Bituminous Coating			
2 x 6	80190	14	\$207.89
2½ x 6	80290	16	\$188.86
3 x 7	80390	24	\$273.19
Fusion Bonded Coating			
2 x 6	80190F	14	\$270.26
2½ x 6	80290F	16	\$245.52
3 x 7	80390F	24	\$355.14

Harco Fittings LLC Price List

Swivel Joint Lateral Connection System

U.S. Patent #7,055,865

LATERAL 90°			
			
(Male NPT x Male NPT)			
SIZE	PART NUMBER	WT	LIST PRICE
Standard Bituminous Coating			
Standard			
1½	80088	5	\$97.13
2	80188	7	\$98.87
2½	80288	8	\$114.46
3	80388	9	\$119.67
1" Side Outlet			
1½	800882	5	\$107.53
2	801882	7	\$109.26
2½	802882	8	\$124.88
3	803882	9	\$128.34
1½" Side Outlet			
2	801883	7	\$119.67
2½	802883	9	\$137.02
3	803883	11	\$142.21

LATERAL 90°			
			
(Male NPT x Male NPT)			
SIZE	PART NUMBER	WT	LIST PRICE
Fusion Bonded Coating			
Standard			
1½	80088F	5	\$126.27
2	80188F	7	\$128.53
2½	80288F	8	\$148.79
3	80388F	9	\$155.57
1" Side Outlet			
1½	800882F	5	\$139.78
2	801882F	7	\$142.04
2½	802882F	8	\$162.35
3	803882F	9	\$166.84
1½" Side Outlet			
2	801883F	7	\$155.57
2½	802883F	9	\$178.12
3	803883F	11	\$184.87

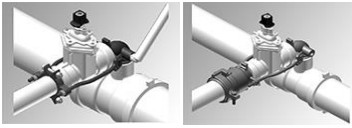
SWIVEL LATERAL KIT			
			
(Push-On Iron Gate Valve) 3x4x7			
SIZE	PART NUMBER	WT	LIST PRICE
Standard Bituminous Coating			
Standard			
2 x 6	8018506K	10	\$164.53
2½ x 6	8028506K	10	\$166.49
3 x 7	8038507K	19	\$204.66
3 x 4 x 7	803048507K	48	\$448.92
1" Side Outlet			
2 x 6	80185062K	10	\$137.02
2½ x 6	80285062K	10	\$175.16
3 x 7	80385072K	19	\$209.85
3 x 4 x 7	8030485072K	48	\$450.34
1" Side Outlet Plugged			
2 x 6	80185062PK	10	\$142.21
2½ x 6	80285062PK	10	\$178.64
3 x 7	80385072PK	19	\$215.05
3 x 4 x 7	8030485072PK	48	\$372.88

(Swivel Tee, Valve not included)

Compatible IPS Push Joint valves: American Flow Control, AVK, Clow, Kennedy, Matco-Norca, M&H, Nibco, Waterous

Harco Fittings LLC's standard Swivel System utilizes one unique size for the female to male swivel joint connection. All swivel male parts, regardless of functional size, fit all female swivel outlets of Swivel Tees and Swivel Saddles.

Harco Fittings LLC Price List

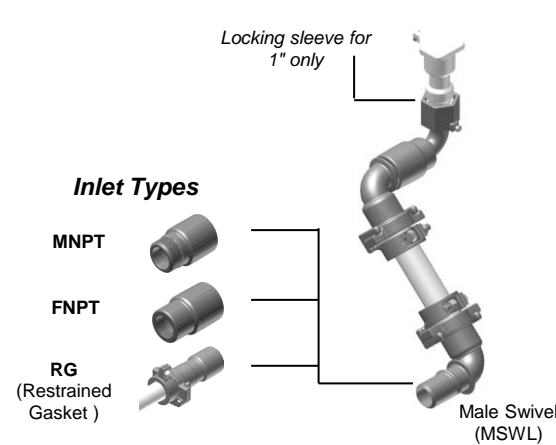

Swivel Joint Lateral Connection System

U.S. Patent #7,055,865



Locking sleeve for 1" only

Inlet Types

- MNPT** 
- FNPT** 
- RG (Restrained Gasket)** 

Male Swivel (MSWL)

SWING JOINT

SIZE (INLET x OUTLET)	PART NUMBER	WT	LIST PRICE
Standard Bituminous Coating			
1 FNPT x 3/4 MNPT	878-10-08	19	\$225.46
1 FNPT x 1 MNPT	878-10-10	18	\$286.56
1 1/2 FNPT x 1 MNPT	878-15-10	17	\$269.59
1 1/2 MNPT x 1 MNPT	877-15-10	19	\$280.84
2 MNPT x 1 MNPT	877-20-10	17	\$262.00
1 1/2 RG x 1 MNPT	879-15-10	21	\$340.05
1 1/2 RG x 1 1/2 MNPT	879-15-15	21	\$422.00
1 1/2 MSWL x 1 MNPT	881-15-10	14	\$236.04
1 1/2 MSWL x 1 1/2 MNPT	881-15-15	15	\$318.37
Fusion Bonded Coating			
1 FNPT x 3/4 MNPT	878-10-08F	19	\$293.09
1 FNPT x 1 MNPT	878-10-10F	18	\$372.53
1 1/2 FNPT x 1 MNPT	878-15-10F	17	\$350.46
1 1/2 MNPT x 1 MNPT	877-15-10F	19	\$365.09
2 MNPT x 1 MNPT	877-20-10F	17	\$340.60
1 1/2 RG x 1 MNPT	879-15-10F	21	\$442.07
1 1/2 RG x 1 1/2 MNPT	879-15-15F	21	\$548.61
1 1/2 MSWL x 1 MNPT	881-15-10F	14	\$306.85
1 1/2 MSWL x 1 1/2 MNPT	881-15-15F	15	\$413.88

Knuckle bolt torque: 35 ft-lbs.

Quick Coupler Valve and pipe not included. Quick Coupler Anchor purchased separately may be used instead of locking sleeve. Call for other inlets and outlets.

HARCO's standard Swivel System utilizes one unique size for the female and male swivel joint connection. All swivel male parts, regardless of functional size, fit all female swivel outlets of Swivel Tees and Swivel Saddles.

Harco Fittings LLC Price List

Swivel Joint Lateral Connection System

U.S. Patent #7,055,865

HARCO SPECIAL 1½" LATERAL CONNECTION SYSTEM

SWIVEL TEE			
			
(1½" Female Swivel Outlet)			
SIZE	PART NUMBER	WT	LIST PRICE
Standard Bituminous Coating			
2 x 1½	8015403	12	\$182.12
2½ x 1½	8025403	12	\$182.12
3 x 1½	8035403	14	\$194.24
4 x 1½	8045403	16	\$218.53
6 x 1½	8065403	23	\$272.28
8 x 1½	8085403	47	\$534.95
Fusion Bonded Coating			
2 x 1½	8015403F	12	\$236.75
2½ x 1½	8025403F	12	\$236.75
3 x 1½	8035403F	14	\$252.51
4 x 1½	8045403F	16	\$284.08
6 x 1½	8065403F	23	\$353.97
8 x 1½	8085403F	47	\$695.44

For use with 80090DK and 881-XX-YY Ductile Iron Swing Joints.

SPECIAL KITS			
  			
SIZE	PART NUMBER	WT	LIST PRICE
Standard Bituminous Coating			
1½" Gasket Knuckle Swing Joint Assembly	875-015	11	\$275.98
1½" Lateral 90° Kit (MSWL x Gasket)	80090DK	5	\$115.10
2" Lateral 90° Kit (MSWL x Gasket)	80190DK	13	\$164.26
Fusion Bonded Coating			
1½" Gasket Knuckle Swing Joint Assembly	875-015F	11	\$394.65
1½" Lateral 90° Kit (MSWL x Gasket)	80090DKF	5	\$164.59
2" Lateral 90° Kit (MSWL x Gasket)	80190DKF	13	\$234.89

Part #80090DK: For use with Swivel Tees with 1½" Female Swivel, part number series 8xx5403

Part #80190DK: For use with standard Swivel Tees, part number series 8xx5405

Knuckle bolt torque: 35 ft-lbs.

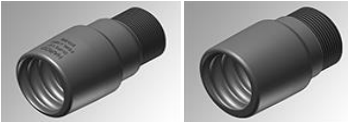
SWIVEL ADAPTERS			
			
(1½" Female Swivel x Male NPT)			
SIZE	PART NUMBER	WT	LIST PRICE
Standard Bituminous Coating			
1½ x 1½	873-006	3	\$98.87
1½ x 2	876-008	2	\$89.87
Fusion Bonded Coating			
1½ x 1½	873-006F	3	\$128.53
1½ x 2	876-008F	2	\$116.83

HARCO's standard Swivel System utilizes one unique size for the female and male swivel joint connection. All swivel male parts, regardless of functional size, fit all female swivel outlets of Swivel Tees and Swivel Saddles.

Harco Fittings LLC Price List

Joint Restraints

KNUCKLE RESTRAINT

U.S. Patent #7,552,949

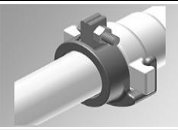

(Fitting to Pipe)

SIZE	PART NUMBER	WT	LIST PRICE
Standard Bituminous Coating			
1½	60-100-01	1.9	\$56.42
2	60-100-02	2.5	\$61.97
2½	60-100-25	3.2	\$70.97
3	60-100-03	3.4	\$76.29
4	60-100-04	5.8	\$126.45

Bolt torque: 35 ft-lbs

Must be loaded onto fitting before pipe insertion.

FITTING to PIPE RESTRAINT

(Clamshell Restraint)



SIZE	PART NUMBER	WT	LIST PRICE
Standard Bituminous Coating			
4	820411	11	\$147.81
6	820611	12	\$192.31
8	820811	16	\$258.21
10	821011	29	\$349.03
12	821211	38	\$464.77
Fusion Bonded Coating			
4	820411FS	11	\$192.15
6	820611FS	12	\$250.01
8	820811FS	16	\$335.68
10	821011FS	29	\$453.74
12	821211FS	38	\$604.20

Price is for one (1) set including two (2) clamp halves and four (4) clamp bolts with nuts. "FS" includes SS hardware.

FITTING to PIPE RESTRAINT

(Style A)

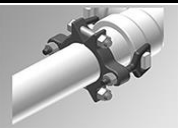

SIZE	PART NUMBER	WT	LIST PRICE
Standard Bituminous Coating			
2	820110	4	\$96.15
2½	820210	4	\$105.06
3	820310	5	\$113.96
4	820410	8	\$147.81
6	820610	10	\$192.31
8	820810	15	\$258.21

Style A: Price is for one (1) set including one (1) clamp and bolt set, and two (2) eye bolts with nuts.

KNUCKLE RESTRAINT

With SS Grip Ring

U.S. Patent #7,552,949

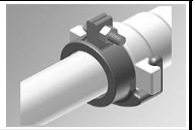

(Fitting to Pipe)

SIZE	PART NUMBER	WT	LIST PRICE
Standard Bituminous Coating			
1½	60-100-01SG	1.9	\$96.17
2	60-100-02SG	2.5	\$96.17
2½	60-100-25SG	3.2	\$110.14
3	60-100-03SG	3.4	\$118.38
4	60-100-04SG	5.8	\$196.20
Fusion Bonded Coating			
1½	60-100-01SGF	1.9	\$125.02
2	60-100-02SGF	2.5	\$125.02
2½	60-100-25SGF	3.2	\$143.19
3	60-100-03SGF	3.4	\$153.90
4	60-100-04SGF	5.8	\$255.05

Bolt torque: 35 ft-lbs

Must be loaded onto fitting before pipe insertion.

QUICK COUPLER ANCHOR

U.S. Patent #7,255,124

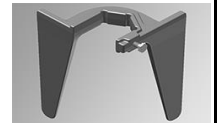

SIZE	PART NUMBER	WT	LIST PRICE
Standard Bituminous Coating			
¾ or 1	82201	2	\$37.40
1½	82202	2	\$39.18
Fusion Bonded Coating			
¾ or 1	82201F	2	\$48.62
1½	82202F	2	\$50.94

FITTING to PIPE RESTRAINT

(Style C)

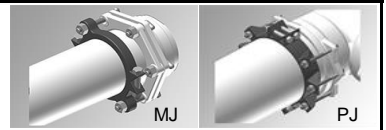

SIZE	PART NUMBER	WT	LIST PRICE
Standard Bituminous Coating			
14	821410	50	\$1,101.77
16	821610	55	\$1,220.82
Fusion Bonded Coating			
14	821410FS	50	\$1,432.30
16	821610FS	55	\$1,587.07

For use with MJ and PJ fittings. "FS" includes SS hardware.

Grip Ring bolt torque: Minimum 130 ft-lbs

Grip Ring bolt torque: 100 ft-lbs
Knuckle bolt torque: 35 ft-lbs

Harco Fittings LLC Price List

Joint Restraints

FITTING to VALVE RESTRAINT



SIZE	PART NUMBER	WT	LIST PRICE
Standard Bituminous Coating			
3	820320	5	\$81.91
4	820420	7	\$105.06
6	820620	8	\$117.52
8	820820	11	\$142.45

Price is for one (1) set including backup ring and two (2) eye bolts with nuts.

FITTING to VALVE to PIPE RESTRAINT

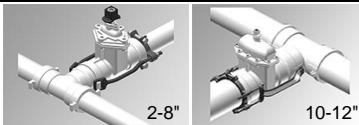

(Style A)

SIZE	PART NUMBER	WT	LIST PRICE
Standard Bituminous Coating			
2	820121	6	\$277.78
2½	820221	6	\$288.49
3	820322	8	\$295.60
4	820422	10	\$325.89
6	820622	14	\$377.51
8	820822	22	\$434.50
10	821021	50	\$564.50
12	821221	60	\$682.03

Price is for one (1) set including one (1) clamp and bolt set, and restraint rods and nuts as required.

FITTING to VALVE to PIPE RESTRAINT



(Style B)

SIZE	PART NUMBER	WT	LIST PRICE
Standard Bituminous Coating			
3	820321	8	\$295.60
4	820421	10	\$325.89
6	820621	14	\$377.51
8	820821	22	\$434.50

Price is for one (1) set including two (2) backup rings, one (1) clamp and bolt set, two (2) eye bolts with nuts, and two (2) T-Bolts with nuts.

Grip Ring bolt torque: 100 ft-lbs
Knuckle bolt torque: 35 ft-lbs

PIPE to PIPE RESTRAINT

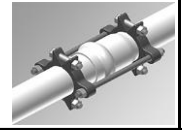

(Style A)

SIZE	PART NUMBER	WT	LIST PRICE
Standard Bituminous Coating			
2	820115	7	\$115.76
2½	820215	7	\$144.24
3	820315	10	\$217.25
4	820415	14	\$267.10
6	820615	18	\$349.03
8	820815	26	\$438.06
10	821015	47	\$822.70
12	821215	52	\$1,041.72
14	821415	113	\$2,060.23
16	821615	133	\$2,450.45
Fusion Bonded Coating			
2	820115FS	7	\$150.49
2½	820215FS	7	\$187.52
3	820315FS	10	\$282.43
4	820415FS	14	\$347.23
6	820615FS	18	\$453.74
8	820815FS	26	\$569.48
10	821015FS	47	\$1,069.51
12	821215FS	52	\$1,354.24
14	821415FS	113	\$2,678.30
16	821615FS	133	\$3,185.58

Price is for one (1) set consisting of two (2) clamp and bolt sets and two (2) restraint rods with six (6) restraint rod nuts. "FS" includes SS hardware.

PIPE to PIPE RESTRAINT

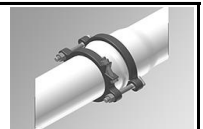

(Style B)

SIZE	PART NUMBER	WT	LIST PRICE
Standard Bituminous Coating			
3	820316	8	\$217.25
4	820416	12	\$267.10
6	820616	16	\$349.03
8	820816	34	\$438.06
Fusion Bonded Coating			
3	820316FS	8	\$282.43
4	820416FS	12	\$347.23
6	820616FS	16	\$453.74
8	820816FS	34	\$569.48

Price is for one (1) set consisting of one (1) clamp and bolt set, one (1) backup ring, and two (2) T-bolts with nuts. "FS" includes SS hardware.

Harco Fittings LLC Price List

Joint Restraints

PVC PIPE

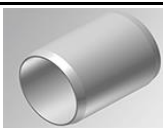

(Factory Beveled, SDR-21)

SIZE	PART NUMBER	WT	LIST PRICE
2	820123	1	\$8.91
2½	820223	1	\$10.68
3	820323	1	\$10.68
4	820423	2	\$14.25
6	820623	5	\$24.93
8	820823	8	\$35.08
10	821023	12	\$62.34
12	821223	16	\$92.60

Length is compatible with valves noted when used with HARCO fittings and valve restraints.

VALVE to PIPE RESTRAINT



(Style A)

SIZE	PART NUMBER	WT	LIST PRICE
Standard Bituminous Coating			
3	820325	10	\$349.03
4	820425	14	\$409.57
6	820625	18	\$505.73
8	820825	26	\$635.72
Fusion Bonded Coating			
3	820325FS	10	\$453.74
4	820425FS	14	\$532.44
6	820625FS	18	\$657.45
8	820825FS	26	\$826.44

Price is for one (1) set including two (2) clamp and bolt sets, two (2) backup rings, and four (4) T-Bolts with nuts. "FS" includes SS hardware.

VALVE to PIPE RESTRAINT

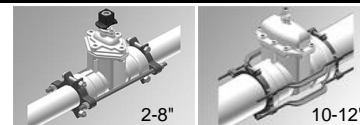

(Style B)

SIZE	PART NUMBER	WT	LIST PRICE
Standard Bituminous Coating			
2	820125	7	\$308.08
2½	820225	7	\$334.79
3	820326	13	\$349.03
4	820426	17	\$409.57
6	820626	22	\$505.73
8	820826	33	\$635.72
10	821025	47	\$852.97
12	821225	52	\$1,070.22
Fusion Bonded Coating			
2	820125FS	7	\$400.50
2½	820225FS	7	\$435.23
3	820326FS	13	\$453.74
4	820426FS	17	\$532.44
6	820626FS	22	\$657.45
8	820826FS	33	\$826.44
10	821025FS	47	\$1,108.87
12	821225FS	52	\$1,391.29

Price is for one (1) set including two (2) clamp and bolt sets, and restraint rods with nuts as required. "FS" includes SS hardware.

Grip Ring bolt torque: 100 ft-lbs
Knuckle bolt torque: 35 ft-lbs

Valve restraints fit the following IPS Push Joint brands: American Flow Control, AVK, Clow, Kennedy, Matco-Norca, M&H, Nibco, Waterous. These restraints are not compatible with DIPS Push Joint valves equipped with IPS transition gaskets.

Harco Fittings LLC Price List

Joint Restraints

RESTRAINT RODS & BOLTS  (Price includes nuts)				
DESCRIPTION	PART NUMBER	WT	STYLE	LIST PRICE
5/8 x 3 Joint Restraint Bolt	82001	1	A	\$26.72
3/4 x 3 Joint Restraint Bolt	82002-3	1	A	\$30.28
for 2" - 3" Valve to Pipe Rod	820021-17	1	D	\$56.98
for 4" Valve to Pipe Rod	820021-20	2	D	\$69.45
for 6" Valve to Pipe Rod	820021-23	3	D	\$87.26
for 8" Valve to Pipe Rod	820021-26	4	D	\$108.64
for 10" - 12" Valve to Pipe Rod	820021-33	6	D	\$115.76
for 2" - 3" Fitting-Valve-Pipe Rod	82001-12	2	B	\$49.86
for 4" Fitting-Valve-Pipe Rod	82002-15	3	B	\$83.70
for 6" Fitting-Valve-Pipe Rod	82002-19	4	B	\$96.15
for 8" Fitting-Valve-Pipe Rod	82002-21	5	B	\$112.19
for 10" Fitting-Valve-Pipe Rod	82010C	12	B	\$144.24
for 12" Fitting-Valve-Pipe Rod	82012C	17	B	\$172.74
5/8 x 5 T-Bolt	82006	1	C	\$17.81
3/4 x 6 T-Bolt	82007	1	C	\$24.93
3/4 x 6 T-Bolt SS	82007S	1	C	\$32.40
3/4 x 9 T-Bolt	T-BOLT-9	1	C	\$33.84
3/4 x 11 T-Bolt	T-BOLT-11	2	C	\$56.98

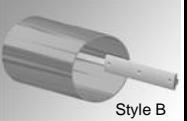
PE PIPE STIFFENER  Style B				
SIZE	SDR	PART NUMBER	WT	LIST PRICE
2	9	825-020-IPS9	0.3	\$92.97
	11	825-020-IPS11	0.4	\$92.97
	13.5	825-020-IPS13.5	0.9	\$92.97
3	9	825-030-IPS9	-	\$169.18
	11	825-030-IPS11	0.9	\$169.18
	13.5	825-030-IPS13.5	1	\$169.18
	15.5	825-030-IPS15.5	1	\$169.18
	17	825-030-IPS17	1	\$169.18
4	21	825-030-IPS21	1	\$169.18
	9	825-040-IPS9	4	\$181.63
	11	825-040-IPS11	1.9	\$181.63
	13.5	825-040-IPS13.5	1.9	\$181.63
	15.5	825-040-IPS15.5	1.9	\$181.63
6	17	825-040-IPS17	1.9	\$181.63
	21	825-040-IPS21	1.9	\$181.63
	9	825-060-IPS9	2.8	\$210.13
	11	825-060-IPS11	3.1	\$210.13
	13.5	825-060-IPS13.5	2.6	\$210.13
8	15.5	825-060-IPS15.5	-	\$210.13
	17	825-060-IPS17	3.1	\$210.13
	21	825-060-IPS21	3.5	\$210.13
	26	825-060-IPS26	-	\$210.13
	9	825-080-IPS9	3.8	\$235.06
10	11	825-080-IPS11	3.9	\$235.06
	13.5	825-080-IPS13.5	4.1	\$235.06
	15.5	825-080-IPS15.5	-	\$235.06
	17	825-080-IPS17	4.3	\$235.06
12	21	825-080-IPS21	-	\$235.06
	9	825-100-IPS9	4.8	\$269.03
	11	825-100-IPS11	4.8	\$269.03
	13.5	825-100-IPS13.5	5	\$269.03
	15.5	825-100-IPS15.5	5.3	\$269.03
14	17	825-100-IPS17	-	\$269.03
	9	825-120-IPS9	-	\$330.35
	11	825-120-IPS11	5.6	\$330.35
	13.5	825-120-IPS13.5	5.3	\$330.35
	15.5	825-120-IPS15.5	-	\$330.35
16	17	825-120-IPS17	6.1	\$330.35
	9	825-140-DIPS9	-	\$665.70
	11	825-140-DIPS11	-	\$665.70
18	13.5	825-140-DIPS13.5	-	\$665.70
	9	825-160-DIPS9	-	\$815.33
20	11	825-160-DIPS11	-	\$815.33
	13.5	825-160-DIPS13.5	-	\$815.33

Use PE Pipe Stiffeners when PE Pipe is used with DI Fittings.
Call for other SDR's. Lead times may vary.

Harco Fittings LLC Price List

Threaded Fittings

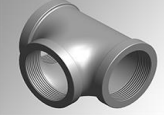
TEE			
			
SIZE	PART NUMBER	WT	LIST PRICE
Standard Bituminous Coating			
1½	88115	2	\$54.79
2	88120	3	\$77.35
2½	88125	5	\$195.36
* 3	88130	7	\$255.70
Fusion Bonded Coating			
1½	88115F	2	\$71.23
2	88120F	3	\$100.56
2½	88125F	5	\$253.97
* 3	88130F	7	\$332.40

* Malleable Iron

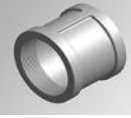
COUPLING			
			
SIZE	PART NUMBER	WT	LIST PRICE
Standard Bituminous Coating			
1½	88015	1	\$29.63
2	88020	1	\$44.26
2½	88025	3	\$94.06
* 3	88030	3	\$164.30
Fusion Bonded Coating			
1½	88015F	1	\$38.52
2	88020F	1	\$57.54
2½	88025F	3	\$122.28
* 3	88030F	3	\$213.58

* Malleable Iron

REDUCER BUSHING			
			
SIZE	PART NUMBER	WT	LIST PRICE
Standard Bituminous Coating			
1¼ x 1	8851210	1	\$17.79
1½ x 1	8851510	1	\$20.27
1½ x 1¼	8851512	1	\$20.27
2 x 1	8852010	1	\$28.36
2 x 1¼	8852012	1	\$28.36
2 x 1½	8852015	1	\$29.38
* 2½ x 1½	8852515	1	\$40.89
* 2½ x 2	8852520	1	\$40.58
* 3 x 2	8853020	1	\$55.61
* 3 x 2½	8853025	2	\$56.44
Fusion Bonded Coating			
1¼ x 1	8851210F	1	\$23.12
1½ x 1	8851510F	1	\$26.35
1½ x 1¼	8851512F	1	\$26.35
2 x 1	8852010F	1	\$36.87
2 x 1¼	8852012F	1	\$36.87
2 x 1½	8852015F	1	\$38.20
* 2½ x 1½	8852515F	1	\$53.15
* 2½ x 2	8852520F	1	\$52.75
* 3 x 2	8853020F	1	\$72.29
* 3 x 2½	8853025F	2	\$73.37

* Malleable Iron

REDUCER COUPLING			
SIZE	PART NUMBER	WT	LIST PRICE
Standard Bituminous Coating			
2 x 1	8802010	-	\$33.86
2 x 1½	8802015	1.3	\$33.86
Fusion Bonded Coating			
2 x 1	8802010F	-	\$43.15
2 x 1½	8802015F	-	\$43.15

90° BEND			
			
SIZE	PART NUMBER	WT	LIST PRICE
Standard Bituminous Coating			
1½	88215	1	\$37.33
2	88220	2	\$56.42
2½	88225	4	\$123.56
* 3	88230	5	\$186.24
Fusion Bonded Coating			
1½	88215F	1	\$48.53
2	88220F	2	\$73.34
2½	88225F	4	\$160.63
* 3	88230F	5	\$242.11

* Malleable Iron

Harco Fittings LLC Price List

Threaded Fittings

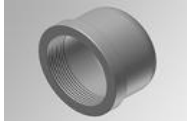
CAP			
			
SIZE	PART NUMBER	WT	LIST PRICE
Standard Bituminous Coating			
1½	88403	1	\$32.11
2	88404	1	\$43.26
2½	88405	2	\$120.12
* 3	88406	3	\$112.11
Fusion Bonded Coating			
1½	88403F	1	\$41.74
2	88404F	1	\$56.24
2½	88405F	2	\$156.16
* 3	88406F	3	\$145.75

* Malleable Iron

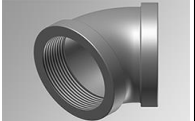
45° BEND			
			
SIZE	PART NUMBER	WT	LIST PRICE
Standard Bituminous Coating			
1½	88315	1	\$56.42
2	88320	2	\$65.22
2½	88325	3	\$165.91
* 3	88330	5	\$223.85
Fusion Bonded Coating			
1½	88315F	1	\$73.34
2	88320F	2	\$84.78
2½	88325F	3	\$215.69
* 3	88330F	5	\$291.01

* Malleable Iron

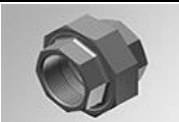
UNION			
			
SIZE	PART NUMBER	WT	LIST PRICE
Standard Bituminous Coating			
1½	88615	2	\$142.56
2	88620	3	\$179.78
* 2½	88625	4	\$300.92
* 3	88630	5	\$365.21
Fusion Bonded Coating			
1½	88615F	2	\$185.33
2	88620F	3	\$233.72
* 2½	88625F	4	\$391.19
* 3	88630F	5	\$474.77

* Malleable Iron

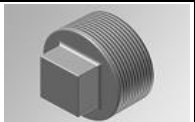
PLUG			
			
SIZE	PART NUMBER	WT	LIST PRICE
Standard Bituminous Coating			
1	88102	1	\$8.23
1½	88103	1	\$13.57
2	88104	1	\$19.89
* 2½	88105	1	\$38.78
* 3	88106	2	\$53.15
Fusion Bonded Coating			
1	88102F	1	\$10.70
1½	88103F	1	\$17.65
2	88104F	1	\$25.85
* 2½	88105F	1	\$50.41
* 3	88106F	2	\$69.10

* Malleable Iron

Harco Fittings LLC Price List

Threaded Fittings

NIPPLE			
(T.O.E. Nipples available)			
(Male NPT x Male NPT)			
SIZE	PART NUMBER	WT	LIST PRICE
Standard Bituminous Coating			
1½ x Close	87015-00	1	\$18.77
1½ x 2	87015-02	1	\$18.77
1½ x 3	87015-03	2	\$20.85
1½ x 4	87015-04	2	\$22.92
1½ x 6	87015-06	3	\$33.35
1½ x 8	87015-08	4	\$45.85
1½ x 10	87015-10	5	\$56.28
1½ x 12	87015-12	5	\$66.69
2 x Close	87020-00	1	\$22.92
2 x 3	87020-03	2	\$22.92
2 x 4	87020-04	2	\$29.17
2 x 6	87020-06	3	\$43.77
2 x 8	87020-08	5	\$58.34
2 x 10	87020-10	6	\$70.85
2 x 12	87020-12	7	\$85.45
2½ x 4	87025-04	3	\$64.60
2½ x 6	87025-06	4	\$75.02
2½ x 8	87025-08	6	\$87.53
2½ x 10	87025-10	7	\$97.94
2½ x 12	87025-12	9	\$127.12
3 x Close	87030-00	2	\$64.60
3 x 3	87030-03	3	\$66.69
3 x 4	87030-04	4	\$66.69
3 x 6	87030-06	5	\$81.28
3 x 8	87030-08	7	\$95.87
3 x 10	87030-10	9	\$116.70
3 x 12	87030-12	11	\$143.80

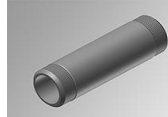

316 SS PLUG			
SIZE	PART NUMBER	WT	LIST PRICE
1	841106-06	0.2	\$16.23

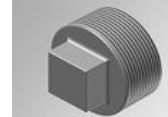

While supplies last

Harco Fittings LLC Price List

Ductile Iron IPS & DIPS Fittings for PVC Pipe

Domestic Push Joint fittings are available in many configurations; Call for price and availability
Mechanical Joint Fittings are available; Call for price and availability

Conditions of Sale

RETURNS: All returned merchandise must have authorization from Harco. Returned merchandise will only be accepted within one (1) year of the date of invoice. Merchandise must be in new and marketable condition. Freight charges on authorized returns must be prepaid and a restocking charge will be made except for returns resulting from shipping errors on our part or material proven to be defective.

CLAIMS: All claims for damage or shortage in transit shall be handled with the carrier by the consignee.

LIMITED GUARANTEE: The Harrington Corporation (Seller) guarantees to credit against invoice price or, at its option, to furnish, but not to install, replacement parts of like kind, F.O.B. Seller's manufacturing plant of origin, any item of its manufacture proved to be defective in material or workmanship within one (1) year from date of shipment provided Buyer (or Purchaser) gives immediate written notice of such alleged defect and, if required, returns defective item to Seller's Lynchburg, Virginia plant freight prepaid. Items or components not of Seller's manufacture are not included in the foregoing guarantee but are subject only to any warranty of their respective manufacturers. Seller shall not be liable for the cost of any repairs or work done or materials used by the Buyer because of defective or non-conforming items, unless authorized in writing by Seller. IN NO EVENT SHALL SELLER BE LIABLE FOR INCIDENTAL OR CONSEQUENTIAL DAMAGES CAUSED BY BREACH OF THIS GUARANTEE unless applicable federal or state law forbids exclusion of incidental or consequential damages.

WARRANTY: EXCEPT FOR THE ABOVE "GUARANTEE," SELLER MAKES NO EXPRESS WARRANTIES AND NO IMPLIED WARRANTIES OF MERCHANTABILITY OR FITNESS FOR ANY PARTICULAR PURPOSE AS TO PRODUCTS SOLD BY US, UNLESS APPLICABLE FEDERAL OR STATE LAW FORBIDS SUCH DISCLAIMER OF WARRANTIES. TO THE EXTENT THAT APPLICABLE FEDERAL OR STATE LAW FORBIDS THE DISCLAIMER OF IMPLIED WARRANTIES OF MERCHANTABILITY OR FITNESS FOR ANY PARTICULAR PURPOSE, SUCH IMPLIED WARRANTIES ARE LIMITED TO THE SAME DURATION (ONE YEAR) AS SELLER'S ABOVE GUARANTEE. NO WAIVER, ALTERATION, OR MODIFICATION OF THIS DISCLAIMER OF WARRANTIES SHALL BE VALID UNLESS MADE IN WRITING AND SIGNED BY AN EXECUTIVE OFFICER OF SELLER.

PRICES: Subject to change without notice. Possession of price sheets does not constitute an obligation to sell and orders may be refused without cause.

SUITABILITY: Contact with corrosive soils or carried water may require the use of protective measures for metallic components. It is the responsibility of the Buyer to determine both the need for protective measures and type of protective measures required. Buyer is solely responsible for the effectiveness of protective measures used.



Warehouses in Virginia, Florida, Texas, Arizona and Wisconsin



ENGINEERED FOR DURABILITY