



Site Equipment

**making
hard work
easier**

List of Contents

■ Site Equipment

Product Categories 1 – 9



1	PAVE EDGE	5
2	Compaction and Surface Savers	9
3	Screeding	11
4	Professional Tools	15
5	Vacuum Laying	27
6	Clamps and Handling	37
8	Civil Engineering: Manhole and Pipe Laying	41
9	Highrise and Yard Handling	47

1

PAVE EDGE



Benefits:

PAVE EDGE is the highest performing paver edging in the industry & professional's choice for 30+ years!

- Best defense against shifting and deformation
- Contains up to 60% more material by weight per foot than other paver edge restraints
- Eliminate frost heave with the lip
- Environmentally engineered and pure virgin recycled PVC material
- Designed for pedestrian, vehicular and commercial applications

Materials and Design:**Polyvinyl Chloride**

- 100% pure virgin and recycled, environmentally safe PVC
- Virgin PVC retains its superior strength and has "memory". So, as it moves under load, it returns to original its shape.

Triangular, Reinforced Design

- Ensures vertical wall stays perpendicular to the pavement
- Best structural support for straight edges & smooth curves
- Hollow core design does not act as a heat sink
- Allows a minimum of 2" of top soil or sod above PAVE EDGE to top of paver

Frictional Holding Rib

- Provides lateral load resistance by 'biting' into the aggregate base (US Patent # 5,073,061)

Frost Heave / Sand Retention Lip

- Utilizes downward pressure of load and weight of pavers to lock edging into base
- Guarantees edging will move with pavement system under all weather conditions
- Bedding sand will not migrate

Pre-Drilled Spike Holes

- Accommodates 1/2" diameter steel landscape spikes
- Spaced every 12" on RIGID. For further strength, drive spikes anywhere along the back support
- FLEXIBLE has one hole per back support to provide optimal support on curves

Connector Tubes

- Pre-inserted into the ends of PAVE EDGE for seamless connections at all joints

**Engineer Tested and Proven**

Stork Twin City Testing Corporation did mechanical engineering pavement loading & deformation testing on material, design, and spiking frequency that prove PAVE EDGE is the highest performing edging in the industry!

The superior design and material resists movement and makes PAVE EDGE Restraint outperform all others! The higher the load, the difference between PAVE EDGE & competitors grow!

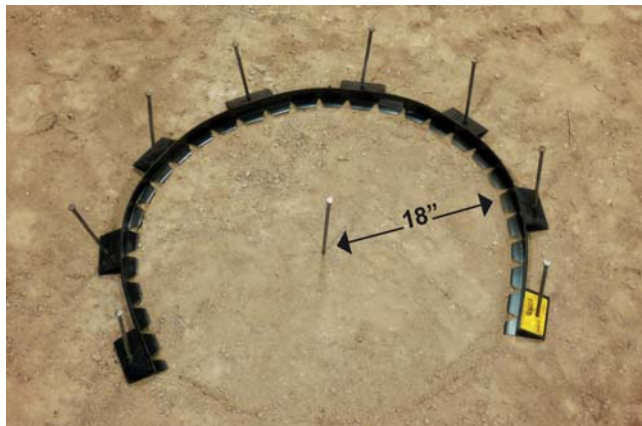

Rigid

Rigid can be used as a flexible edge restraint. A 7 ft section can be flexed slightly to produce a contour with a radius limit of approximately 17 ft. The rigid model is ideal for straight runs and gentle curves with minimal spikes.

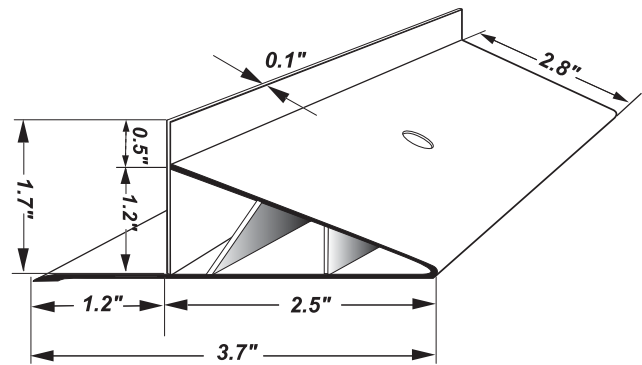

Rigid

Type	Description	Dead Weight lbs (kg)	Order-Number
Rigid 84 ft Bundle	12 x 7 ft Sections	34 (14.3)	51800122
Rigid 4,116 ft- Pallet	588 x 7 ft Sections	1646(747)	51800122

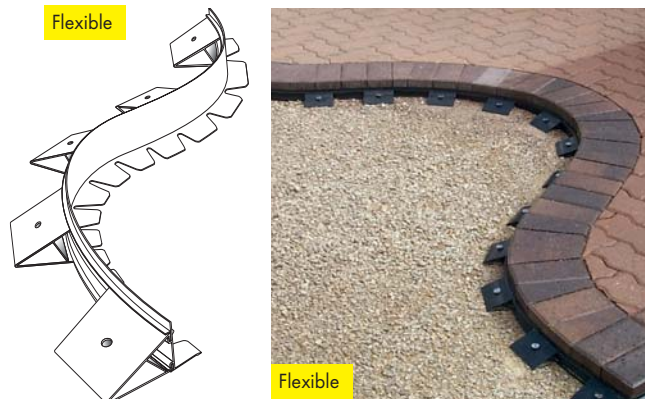

Flexible

Flexible

Flexible

- Can create radius as tight as 18"
- Ideal for tight curves
- Easily makes beautiful curves with perfect transitions and with minimum spikes

Type	Description	Dead Weight lbs (kg)	Order-Number
Flexible 84 ft- Bundle	12 x 7 ft Sections	25 (11.4)	51800123
Flexible- 4,116 ft Pallet	588 x 7 ft Sections	1235 (560)	51800123

Industrial

On heavy-duty commercial and permeable (PICP) applications Industrial has proven itself for decades to be the most economical alternative to poured-in-place concrete curbs. It is the best performing, lowest labor, lowest material cost per foot of any industrial edge restraint.

- Longer extended lip with thicker walls and additional frictional ribs
- Designed for 3-4" (8-10 cm) commercial/industrial pavers
- 10 ft long, straight, one-piece sections
- Pre-drilled holes 6" apart alternating backside/front extension lip
- Connector Pipe shipped one 10 ft section per carton of 120 ft to allow cuts as needed. Recommend connector pieces cut to 10"



Industrial

Type	Description	Dead Weight lbs (kg)	Order-Number
Industrial 120 ft - Bundle	12 x 10 ft Sections	7 (3)	51800117



HiVIZ

HiVIZ™ Safety Edge Restraint

Make your display safer by using a transitional strip. The HiVIZ sits on floor to meet the top of your display, reducing tripping and holding it together.

- Great for tradeshow and displays
- Safety bright yellow PAVE EDGE

Type	Description	Dead Weight lbs (kg)	Order-Number
84 ft Bundle	(12 x 7 ft Sections)	41 (19)	51800118
Single 7 ft bundle		1.5 (3)	51800118

2

Compaction and Surface Savers





SurfaceSAVER Roller Plate Attachment



SS70



SS90



SurfaceSAVER MAT

SurfaceSAVER™ Roller Plate Attachment

Leading slab manufacturers recommend roller compactors to avoid damage. The process is a gentle compression of slabs/pavers into the bedding course. Rollers dampen compaction amplitude and consolidate bedding sand or chip through higher frequency vibration. This prevents the slabs from shifting and edges from chipping. The pavement is also protected from scratches caused by scraping joint sand across the surface.

- Roller diameter: 3 ¾" (9 cm)
- Secure mounting with adjustable width clamps
- SS70 Clamping Range: 15" - 22.5" (39 - 57 cm)
- SS90 Clamping Range: 15.75" - 25.5" (40 - 65 cm)

Type	Dimensions in (cm)	Width in (cm)	Dead-Weight lbs (kg)	Order-Number
SurfaceSAVER 70* Frame Only	19 x 27 ½ x 4 ½ (48 x 69 x 11)	22.8 (58)	109 (49)	41850319-001
SurfaceSAVER 90* Frame Only	19 x 34 ½ x 4 ½ (48 x 88 x 11)	30.7 (78)	138 (63)	41850320-001

SurfaceSAVER™ MAT

New integrated honeycomb technology allows joint sand to spread and fill paver joints 4x faster than before! You can trim this mat to fit almost any compactor plate and use to reduce damage to textured surface pavers, clay brick, natural stone, & paving slabs. Made with special urethane material the PaverSAVER minimizes slowdown.

- Honeycomb urethane rubber mat 22" x 30"
- Helps prevent damage to textured surface pavers, clay brick, natural stone, & paving slabs
- Universal design for use on most compactors
- Trim to fit
- Each kit includes: Mat Plug Cutter (for cutting the bolt holes)
*Not for drilling steel

Type	Dead-Weight lbs (kg)	Order-Number
SurfaceSAVER Mat Universal Kit	15 (7)	201505
Mounting Bracket 1540 & 1550	3 (1.4)	005012

3

Screeding



SandPULL PRO™ / EASYPLAN EP-UNI

- Screenshot standing, not on your knees
- Lightweight hollow core extruded aluminum
- Will not deflect under load
- Increased screeding efficiency
- Width easily adjusts
- Stainless steel extensions



SandPULL PRO



CurbROLLER

CurbROLLER™ / EASYPLAN EP-UNI-RS

- Attachment For SandPULL PRO
- Screenshot off curbs and edges

Type	Description ft (m)	Handle Length in (cm)	Dead-Weight lbs (kg)	Order- Number
SandPULL PRO	3 - 7½ (.9 - 2.3) System	72 (182.8)	33 (15)	51000040
SandPULL PRO	7½ - 10 (2.3 - 3) System	72 (182.8)	35 (16)	51000041
CurbROLLER Kit (Set of 2)	-	-	11 (5)	41000165



LF-125/215

LEVELFIX LF Manual Screeding System – move a large amount of material easily in a short time

The LF system is an efficient tool for landscape contractors who are looking for a tool for spreading and also screeding bedding material for paved areas quickly, flexibly and precisely, while maintaining ergonomically sound posture. Suitable for gardeners for preparation of planting beds, lawn areas and similar. Also suitable for levelling wood chip or gravel paths. Level surfaces can be created in a very short space of time and the process, which uses plastic wheels with flat rubber tread, leaves hardly any traces in the surface.

- Comes in 3 different infinitely adjustable working widths:
 - 40 - 49 in (LEVELFIX LF-75/125)
 - 49 - 85 in (LEVELFIX LF-125/215)
 - 67 - 122 in (LEVELFIX LF-170/310)
- A large amount of material can be moved in a very short time (pre-distribution), and then screeded precisely (finish)
- On both sides infinitely height adjustable wheels, with height indicator for adjusting the surface level to the kerb for instance. Adjustment range -1.5 / +6.5 in

Type	Description	Working Width in (mm)	Dead Weight lbs (kg)	Order-Number
LF-75/125	Consisting of: 1 pair of stainless steel screed blades, 1 x central rolling unit, 1 x handle with holder, 2 x height-adjustable external roller sets	30-49 (750 – 1,250)	50 (22)	51000084
LF-125/215	As LF-75/125, but 2 x roller units	49 - 85 (1,250 – 2,150)	70 (32)	51000085
LF-170/310	As LF-75/125, but 2 x roller units	67 - 122 (1,700 – 3,100)	90 (42)	51000086
LF-HG	Complete handle. incl. bracket for LF-170/310		7 (3)	41000317

- Infinitely adjustable crown profile integrated as standard: LF-75/125: 7%, LF-125/215: 4%, LF-170/310: 2.5 %
- Screed blades made from non-rusting stainless steel



- Cutter with sharp edge on the lower blade edges allows materials to be excavated even where there is compacted sand
- Lasting surface protection on all other components thanks to galvanic zinc plating

- Handle adjustable for optimum ergonomics
- Spirit/bubble level fitted on the top right edge of the screed blade
- Universal tool holder and sweeping broom (recommended primarily for LF-75/125) available as an option
- Second handle for wide working width for 2 people operation for LF-170/310 available as an option



Picture with additional LF-HG



SandMAX I



SandMAX I

SandMAX™ I / Telescope Screeding System TAS-UNI

Screed 7 - 15 ft (210-460 cm) areas of bedding. Maintains downward force and resists lifting off rails.

Maximum width of 19 ft (580 cm) can be achieved with additional 5' 9" segment. A 7 ft long crown segment is available to create a crown or swale of +/- 4% and a max width of 20 ft.

- High tensile aluminum alloy
- Height adjustable rollers
- Screed Width: 7 - 15 ft (210-460 cm)
- Section Length: 5' 9" (175 cm)
- Shovel slots for manual pull & chains for loader pull

Type	Description ft (cm)	Dead-Weight lbs (kg)	Order- Number
SandMAX I	7-15 (210 - 460)	192 (87)	51000068
5' 9" Section (175 cm)	5.75 (175)	27 (12)	41000160
7' Crown Section (210 cm)	7 (210)	61 (27)	41000173

4 Professional Tools



Pounder

The perfect size heavy-duty slide hammer to put optimum compaction force (up to 5,000 lbs) exactly where needed. Designed for small areas, tight corners and directly next to foundations.

- 6 x 6 in (15x15 cm) Tamper Bit (for up to 5,000 lbs of force)
- Pounder Shaft: 20 lb hardened steel hammer 39 in (99 cm) Long
- Quick pin for easy bit change

Pro Tip: A 6" x 6" plate generates the highest compaction. When increased to an 8" x 8" plate you lose 40% of compaction. The larger the plate, the less compaction.

Type	Dead Weight lbs (kg)	Order-Number
Pounder (Tamper Bit Included)	32 (9)	029054



Pounder



KneeSEAT



KneeSEAT

KneeSEAT positions the hip and ankle at a proper angle providing support and comfort to the back, shoulders and neck.

- Ergonomic knee protection & ankle support
- Back relief while kneeling or sitting
- Aluminum tubing is 2x thicker or strength

Type	Dead Weight lbs (kg)	Order-Number
KneeSEAT	4 (1.8)	51800135



PaverPERSUADER

PaverPERSUADER / Rubber Hammer GH-ERGO

- Designed for tightening loose field pavers
- Angled head hits low on the paver to reduce paver rotation and disturbing bedding
- Replaceable heads
- Handle Length: 32" (81 cm)

Type	Handle Length in (cm)	Dead Weight lbs (kg)	Order-Number
PaverPERSUADER	32 (81)	6 (2.7)	51800113

Paver Mallet/Soft-face mallet SXH-1,8

- 13 in handle
- 2³/₈ in (60 mm) changeable heads
- Cast iron head clamp
- Includes: (1) BLACK Medium Hard Rubber and (1) RED Hard Plastic head



Type	Handle Length in (mm)	Dead Weight lbs (kg)	Order-Number
Paver Mallet	13 (330)	4 (1.8)	51800130
Replacement Head Black		3 (1.3)	41800266
Replacement Head Red		6 (2.7)	41800267

Wall Mallet/Soft-face mallet SXH-3,2

- 19 in handle
- 3¹/₈ in (80 mm) interchangeable heads
- Cast iron head clamp
- Includes: (1) Black Medium Hard Rubber and (1) White Very Hard Nylon head



Type	Handle Length in (mm)	Dead Weight lbs (kg)	Order-Number
Wall Mallet	19 (493)	7 (3.2)	51800131
Replacement Head Black		3 (1.3)	41800271
Replacement Head White		6 (2.7)	41800269

Deadblow/SXH-1,3/SXH-2,3

- 12 in handle (Models 375 & 500)
- Welded steel construction
- Includes: (2) White Very Hard Nylon heads



Type	Handle Length in (mm)	Dead Weight lbs (kg)	Order-Number
Deadblow Model 375	12 (305)	3.8 (1.3)	51800127
Deadblow Model 500	12 (305)	5 (2,3)	51800128



Hammers

Sledge Mallet/Soft-face mallet SXH-3,6

- 31 in handle
- 3¹/₈ in (80 mm) interchangeable heads
- Cast iron head clamp
- Includes: (1) Black Medium Hard Rubber and (1) White Very Hard Nylon head



Type	Handle Length in (mm)	Dead Weight lbs (kg)	Order-Number
Sledge Mallet	31 (797)	8 (3.6)	51800145
Replacement Head Black		3 (1.3)	41800271
Replacement Head White		6 (2.7)	41800269

Tumbler/Bush hammer STH-0,9

- 13 in handle
- Gives factory tumbled look
- Creates a "split face" after saw cutting
- Use on retaining wall block or pavers
- Hardened steel head



Type	Handle Length in (mm)	Dead Weight lbs (kg)	Order-Number
Tumbler	13 (330)	3 (.9)	51800129

PaverCART / VTK-V

Optimize your efficiency on the job site with the PaverCART! Move material with less time & energy. No more wheelbarrows.

- 12" diameter pneumatic tires
- Zinc Plated, high tensile steel
- Over-center cam action clamp handle
- Bottom roller for rolling on & off pallets*
- Works with many banded or unbanded pavers
- Carrying Capacity: 880 lb (400 kg)

Type	Working Load Limit WLL* lbs (kg)	Dead Weight lbs (kg)	Order-Number
PaverCART	max. 880 (400)	205 (68)	51100015
VTK-V-SR/N ◉	Supporting wheel for easy handling on even ground. Can be additionally attached at any time	15 (7)	41100041



Type	Length mm (in)	Dead Weight kg (lbs)	Order-Number
GH-RE-TWIN	1,000 (39.37)	3.3 (7.27)	51800166

Rubber Hammer-Alignment Bar GH-RE-TWIN – The 2-in-1 tool for landscapers and road builders – for ergonomic striking and aligning stones

One side is fitted with a rectangular rubber element with a slightly bevelled profile so that the rubber profile meets the stone flat. A wide support with a levelling blade is attached to the second side to align the interlocking blocks that have not yet been vibrated.

- The long wooden handle enables an ergonomic, upright posture
- Highly cushioned rubber head for optimum power transmission and reduced kickback to protect the joints
- With replaceable, robust, sharp-edged spreader blade made of hardened spring steel for levelling interlocking blocks.
- Wide support for driving in the levelling blade
- Plastic impact disc for tapping on the head side enables height corrections of individual paving stones or slabs that are too high. The GH-RE-TWIN can also be placed on this disc in an upright position

PaverADJUSTER / Alignment Bar RE

Drive down into the joint by applying pressure to the foot rest.
Stretch a string line along the bond line and shift the pavers.

- Replaceable spring steel blade
- Hand and foot rests to drive into joint
- Zinc plated
- Handle Length: 36 in (91 cm)

Type	Handle Length in (cm)	Dead Weight lbs (kg)	Order-Number
PaverADJUSTER	36 (91)	3.3 (1.5)	51800011
Adjuster Replacement Blade	-	2 (.9)	41800002



PaverADJUSTER

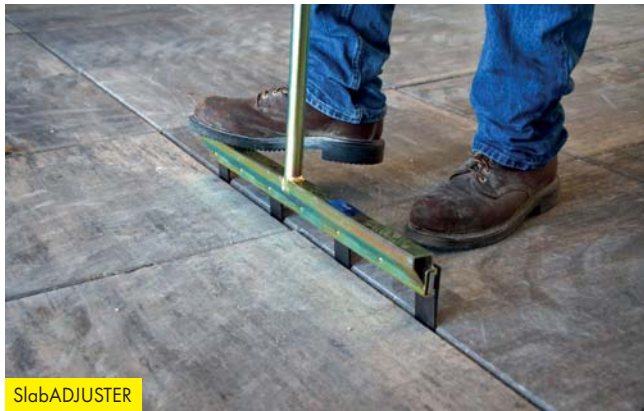

SlabADJUSTER

SlabADJUSTER / Multiple Alignment Bar MRE

- Four adjustable blades
- Speeds up alignment process
- Two grips and one hammering point
- Head Width 25.5" (65 cm)

Type	Handle Length in (cm)	Dead Weight lbs (kg)	Order-Number
SlabADJUSTER	36 (91)	13 (6)	51800045
Adjuster Replacement	-	2 (.9)	41800002

PaverPULLER / Paver Lifter SAH

- Fast removal of unsanded, non-compacted pavers
- Opening Range: 4 - 15 in (9 - 40 cm)
- See Paver Extractor for removal of pavers from a finished pavement

Type	Dead Weight lbs (kg)	Order-Number
PaverPULLER	11 (4.9)	51800050



PaverPULLER

PaverEXTRACTOR / Paving Block Extractor SZ

The professional's answer to paver removal. Serrated spring steel teeth extract a large variety of pavers, including ones without spacer bars. Removing pavers with a PaverEXTRACTOR saves time and protects the surrounding pavers. Save time and money with the right tool for the job.

- Quick pin for fast adjustments
- Replaceable serrated spring steel teeth
- Zinc plated
- Opening Range: 3-13 in (9-33 cm)

Pro Tip: After using water as lubricant, use putty knife to loosen & remove poly sand first.

Type	Opening Range in (mm)	Dead Weight lbs (kg)	Order-Number
PaverEXTRACTOR	3-13 (90-330)	9 (4)	51800030
Extractor Replacement Blades	-	2 (.9)	41800001



PaverEXTRACTOR





SlabEXTRACTOR

SlabEXTRACTOR™ / Slab Extractor PZ

- Two person slab removal
- Quick pin for fast adjustment
- Uses four extractor teeth
- Opening Range: 5" - 24" (13 - 61 cm)
- Lifting Capacity: 150 lb (68 kg)

Type	Opening Range in (cm)	Dead-Weight lbs (kg)	Order-Number
SlabEXTRACTOR	5 - 24 (13 - 61)	13 (6)	53200006
Extractor Replacement Blades	-	2 (.9)	41800001

SlabGRABBER / Professional-Slab Handle PPH

- For Installation, not removal
- Accommodates most slabs & retaining wall blocks
- Pivoting heads provide excellent contact with split face
- Tight, pinch-free, placement at the laying edge
- Gripper Length: 4 in (10 cm)
- Gripper Height: 11/8 in (2.8 cm)
- Carrying Capacity: 130 lbs (58 kg)

Pro Tip: For proper adjustment, make sure the SlabGRABBER arms are at about a 160° angle prior to lifting.

Type	Opening Range in (mm)	Dead Weight lbs (kg)	Order-Number
Small SlabGRABBER	4-15 (101.6-381)	3 (1)	53200053
Medium SlabGRABBER	10-20 (254-508)	3 (1)	53200052
Large SlabGRABBER	14-24 (355.6-609.6)	3 (1)	53200054



SlabGRABBER

Type 3.1 SuperWET Adhesive

- Fast set time and short clamp time
- Works best with moisture present
- Excellent for step veneering and freeze-thaw areas
- Great for areas subjected to heavy loads like step treads and pool coping
- Application range: 35° - 110° F
- 60 lineal feet of bead per tube

Applications

- For Pavers, Retaining Walls and Masonry
- Concrete, Clay and Stone
- Metal, Glass and Wood

Type	Description	Weight lbs (kg)	Order-Number
SuperWET Masterpack	12 x 16 oz bottles	12 (5.4)	41850368



Type 3.1 SuperWET Adhesive



SHIMz

SHIMz™

Recommended for use with pavers, retaining walls, caps, steps, masonry, and outdoor architecture.

- 4x stronger than wood
- Superior alignment and support
- Snaps clean at the pre-scored lines
- Weatherproof polymer will not shrink, warp, rot, or split
- Never becomes brittle and resists UV damage

Type	Dead-Weight lbs (kg)	Order-Number
Case (360 Shimz)	21 lb (9.5 kg)	51800134



StringIT/STRING ALONG SA

This incredibly simple and flexible line holder for all setup work performed with a plumb line.

- Gripping teeth hold the string line safely under tension at all times
- The line can also be removed again at any time without losing the height setting as a result.
- Fits Steel Stakes up to 1"

Type	Dead Weight lbs (kg)	Order-Number
StringIT Display (100) Box	9.4 (4.3)	CT450450

PaverSQUARE PRO & JR

Lightweight aluminum 45° and 90° angles.

Open PaverSQUARE and it's ready to use.

- PRO - Compactly folds to 48 x 2 in (122 x 5 cm). Unfolds to 48 x 48 x 68 in (122 x 122 x 172 cm).
- Jr - Compactly folds to 24 x 2 in (61 x 5 cm). Unfolds to 24 x 24 x 33 in (60 x 60 x 84 cm).
- Compact storage and transport.
- Protective soft cases included.

Type	Dead Weight lbs (kg)	Order-Number
PaverSQUARE Pro	7 (3.2)	51800146
PaverSQUARE Jr	3 (1.4)	51800052



PaverSCRIBE™ / MAL

- Pivoting angle finder to set exact angles
- Measure, lock, and mark paver angles
- Fast & accurate measurement of cuts when installing without a soldier course

Type	Dead Weight lbs (kg)	Order-Number
PaverSCRIBE	1 (.5)	51800026



QuickDRAW™ / QD

- Aluminum construction
- Increase marking speed by 400-600%
- Guide tab glides easily along edge restraints
- Wheel for use against curbs and walls
- Normally for use with soldier course

Type	Dead Weight lbs (kg)	Order-Number
QuickDRAW	4 (1.8)	029026

FlexMARKER™ / FMK

- Complete system for layout and marking of radii
- 2 Flexible 13 ft poles for curved borders (26 ft long)
- Anchor cleats & 12" velcro stays for fast layout
- Connect multiple poles together for unlimited length
- Up to 4 sets of poles (52 ft) fit in the carrying bag

Kit Includes:

- 8 Anchor Cleats
- 2 FlexMARKER 13 ft poles (26 ft total)
- 6 Velcro grade stake stays
- 1 Carrying bag
- 2 PaverMARKERS

Type	Dead Weight lbs (kg)	Order-Number
FlexMARKER Kit	6 (2.3)	51800136
Extra FlexMARKER 13 ft Pole	2 (1)	41800265
Anchor Cleat Each	1 (.5)	41800273





PaverMARKER

PaverMARKER™ / PM

- Wet/dry marker for pavers, block, and stone
- Non-permanent
- Strong composite material
- Extremely long lasting

Type	Dead Weight lbs (kg)	Order-Number
PaverMARKER (100 pcs)	1 (5)	51800125-002
PaverMARKER Private Label (800+ pcs)	-	51800155

Customize Your PAVeRMARKeRS

The great marking tool you depend on can be branded with your company logo or any customized information you choose!

- 2-SIDED
- FULL COLOR
- PROMOTE YOUR PRODUCTS OR BUSINESS

***CUSTOM PRINTED- 800 PIECE MINIMUM
CALL FOR PRICING**

**TO ORDER OR REQUEST A QUOTE CALL: 952-226-6400
OR EMAIL: SALES@PROBST-HANDLING.COM**



Wallsplitter/STS-43-H-EASY

- More splitting force with reduced effort
- Provides same look and texture as factory splits
- Pivoting upper blade ensures uniform contact for clean split
- Durable surface protection by galvanizing
- Clean cuts with precisely guided, triangular, reversible blade
- Perfect alternative to saw cutting

Type	Cutting Height in (cm)	Cutting Length in (cm)	Dead-Weight lbs (kg)	Order-Number
STS-43-H-EASY	12 (30)	17 (43)	160 (72)	51200085



STONE SPLITTER STS-33-EASY

- High rationalisation effect, as clean snapping of the blocks can often replace time-consuming and expensive cutting with masonry saws
- Spring-mounted supporting table (both halves of the table tiltable) allows clean undercut for precise laying without uneven large gaps
- Clean cuts with precisely guided, triangular, reversible blade
- Better view of the cutting line
- Crank on top, connected to spindle via chain and gear drive
- More splitting force with reduced effort
- Size indicator in centimetre and inches as well as 45-degree angle on both support plates speed up the work enormously
- Durable surface protection by galvanizing

Type	Cutting Height in (cm)	Cutting Length in (cm)	Dead-Weight lbs (kg)	Order-Number
STS-33-EASY	0.39 – 4.72 (1 – 12)	13 (33)	105 (48)	51200082

5

Vacuum Laying



Benefits:

Compared to mechanical grabs, vacuum technology provides substantial and numerous benefits in handling and installation of building materials.

1. Installation without joints
2. No edge cracks and chipping
3. Higher laying quality; easy removal and readjustment, such as a slab was placed too deep into the laying course

Porosity:

Failsafe function of the vacuum devices is decisively influenced and determined by the porosity of the elements. It is easy to imagine:

if the incoming air from micro pores exceeds the capacity a vacuum pump or blower is able to exhaust, proper negative pressure between suction plate and construction material cannot be built up.

These kind of products are not suitable to be lifted with vacuum devices. Unlike the surface characteristics and finish, porosity is not apparent or visible to the observer.



Appropriate Device	Vacuum Hand Laying Systems							Vacuum Lifting Devices				Vacuum Hose Lifters				
	VH	FXAH	VPH	VPE	MJ	AIR-LIFT*	Vac WER-KS*	SPEEDY VS*	SM	SH	QUICK-JET QJ	POWER JET PJ	MM with VGE	JUMBO-MOBIL JM	JUMBO BV VARIO	TRANS-MOBIL TM
Vacuum Generation via Vacuum Pump	●	●	●	●	●				●	●						
Vacuum Generation via Vacuum Blower						●	●	●			●	●	●	●	●	●
Specification Material/Product:																
Very dense/not porous: - granite - marble - „WET CAST“ (molded wet concrete)																
Dense/up to slightly porous: - miscellaneous natural stones - specific sandstones - limestone - single layer concrete stones, highly compressed, manufactured with a high content of water/cement																
Moderate porous: - smaller concrete slabs w/facing produced on block making machines																
Highly porous: - larger concrete slabs w/facing produced on block making machines - aerated concrete blocks - exposed aggregate surfacesaking machines																

* Vacuum hand laying device can also be used on attachments via lifting eye.

Marginal conditions, test set-up might be necessary prior to final decision making

Surface:

What really matters in practical application is not that much the surface finish but rather the porosity of the material.

1. Plane and smooth surfaces are optimal. 
2. Slight, not sharp-edged unevenness up to 5 mm is usually not a problem. 

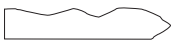
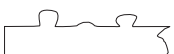
3. Products with severe, not sharp-edged unevenness of approx. 8 to 10 mm can be handled with specific vacuum devices and corresponding sealing systems. 
4. Products with deep unevenness, such as exposed aggregate surfaces are easy to handle with vacuum devices operated by a vacuum blower. 

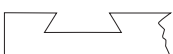
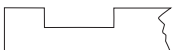
5. Sharp-edged products, with uneven and graded top up to approx. 3 mm are, if at all, solely be handled with vacuum devices equipped with a vacuum blower. 
6. Other surface characteristics on request. 

The smallest value always applies in the case of different load capacity specifications on the vacuum components used (lifting hose, suction plate, vacuum generator e.g. UNIMOBIL etc.)



AIRLIFT

AIRLIFT®

AIRLIFT is designed to make lifting and moving slabs, pavers and even porcelain tiles easy, safe and more ergonomic. AIRLIFT is electric, so it does not require an air compressor like most similar tools. The backpack vacuum is also very light weight and easy to maintain.

Kit Includes:

- BackVac 110v
- One Man T-Handle
- Adjustable Center Post
- 6.5" x 6.5" Suction Plate
- Easy to replace seal



TILE SETTER



6" X 12.5" PLATE



10" LIFT EXTENSION

Type	Dead-Weight lbs (kg)	Order-Number
Airlift Base Kit	18 lb (8 kg)	CT75750
Plate 3" x 11"	2.2 lb (1 kg)	CT70200A
Plate 6.5" x 6.5"	2 lb (1 kg)	CT70165A
Plate 6" x 12.5"	3.3 lb (1.5 kg)	CT70160A
10" Lift Extension	1.5 lb (0.7 kg)	CT014039A
Plate 6" Round	1.2 lb (0.5 kg)	CT70250A
Plate 4" x 15"	2.5 lb (1.1 kg)	CT70150A
Plate 10" x 10"	3.2 lb (1.5 kg)	CT70125A
One Hand Lift Handle	1.2 lb (0.5 kg)	CT70450A
Tile Setter Kit	2.8 lb (1.2 kg)	CT80800

VacWERKS VW-200 BL

- Lifting capacity: 440 lbs (200 kg)
- 110v Turbine Power for Handling All Products - Even DryCast Concrete which other systems fail to lift securely.

BL stands for Blower vacuum. Blower (aka turbine) technology enables us to excel in the most difficult vacuum applications. ie: handling porous materials such as dry cast concrete. Blower vacuum generates a high degree of air volume resulting in a safe and secure grip even as air is lost due to surface textures and the relative porous nature of dry cast concrete. 110v Blower vacuum is your best insurance that the vacuum will work regardless of the properties of the material you and your customers work with.

Type	Weight-Capacity lbs (kg)	Order-Number
VW-150 BL		52710010
110 lbs Plate	110 lb (50 kg)	42710197
210 lbs Plate	210 lb (95 kg)	42710194
330 lbs Plate	330 lb (150 kg)	42710196
440 lbs Plate	440 lb (200 kg)	42710198



*Use with Power Rack - VS-PR



VacWERKS VW-200-BL

SPEEDY POWER-RACK VS-PR

Holder for practical storing of the EU 22i Honda generator when operating the SPEEDY on lifting equipment (e.g. a digger)

- No cumbersome cable to consider
- VS-PR is simply hung on the carrying device with adjusted generator. The VS-EH lifting eye of the SPEEDY is then hung on the eye hook of the VS-PR



Power Rack

Type	Working Load Limit WLL lbs (kg)	Dead Weight lbs (kg)	Order-Number
VS-PR ①	440 (200)	20 (10)	42710166

- In the case of a carrying device with a large lifting height, the eye hook may be connected to the VS-EH*** lifting eye with the 2 m long loop supplied. Thus, first the SPEEDY then the VS-PR can be switched off
- Incl. 3 m extension cable + Velcro strap

SPEEDY VS 110 V / Vacuum Hand Laying Device – new with an integrated suction plate for up to 50 kg

Higher than “others” compressed air converter or battery powered vacuum pumps.

No Need for a heavy Air Compressor and air hoses FAUST („fist“) option connects easily to the SPEEDY 110 V unit for one hand lifting.

- SPEEDY 110v Lifting capacity up to 440 lb (200 kg)
- FAUST Lifting capacity 55 lb (25 kg)
- 20 + years of lifting dry cast, wet cast, ceramic, and porcelain, smooth and textured surfaces
- Draws only 11 amps
- Adjustable handles allow different height operators and fold down for transport and storage
- Long handle option allows handling of larger (36“+) slabs
- Additional optional size suction plates available (see website)
- Lift kit with safety chain option available



VS-GH-SPS-100-50/30



SPEEDY 110 V

NEW: The handles can be rotated 90° by simply repositioning them using the 2 bolts.

Type	Dead-Weight lbs (kg)	Order-Number
SPEEDY VS 110 V	45 (20)	52700019

Accessories:

Type	Description	Dead Weight lbs (kg)	Order-Number
VS-EH	Lifting eye with safety chain	8 (3.5)	42710143

Suction plates for the use of SPEEDY with Quick Change function

Type	Suction Plate Dimension in (mm)	Working Load Limit WLL lbs (kg)	Dead Weight lbs (kg)	Order-Number
VS-GH-SPS-80-40/30	oval 15.74 x 11.81 (400 x 300)	175 (80)	4 (2.0)	42710129
VS-GH-SPS-100-50/30	oval 19.68 x 11.81 (500 x 300)	220 (100)	6 (2.5)	42710130
VS-GH-SPS-140-70/30	oval 27.55 x 11.81 (700 x 300)	310 (140)	7 (3.0)	42710131
VS-GH-SPS-200-85/34	oval 33.46 x 13.38 (850 x 340)	440 (200)	25 (11.5)	42710132

● Durable surface protection by galvanizing

VPH 12 V / VACUUM-POWER-HANDY VPH-GREENLINE

Alternative to the popular SPEEDY VS 110v vacuum comes equipped with telescoping handles and height adjustment for manual lifting of larger slabs. Remove the handles for easy transport. The light weight, ergonomic design reduces fatigue, injury, and speeds installation.

- Lifting capacity: 330 lb (150 kg)
- Included suction plate size: 17 ½" x 10" (44 x 25 cm)
- Lifting loop for easy attachment to equipment
- Rechargeable 12 volt battery means no power cords or electrical source
- Perfect choice for installing granite, bluestone, porcelain or wet cast concrete slabs



Type	Dead-Weight lbs (kg)	Order-Number
VPH 12 volt	35 (16)	52710008

* Value at 500 mbar low pressure.

- Durable surface protection by galvanizing

STONEMAGNET SM – battery-powered vacuum attachment with even greater power

Easy to use, durable, independent with own power supply – the universal unit with a load bearing capacity of up to 1200 kg (1,645 lbs). Flexible and fast installation of primarily vacuum-dense elements, such as stone slabs, concrete elements and steps.

- Can be used with any hoist
- Powered by rechargeable, exchangeable 12 V-AGM battery. Power saving control system makes battery lasting for one whole working day. Battery charger not included
- Charging socket for charging integrated
- With integral chain-box and load-securing chain
- Vacuum suction plates can be easily replaced without tools
- Operating handle optionally available

Additional features of the SM-1200:

The STONEMAGNET SM-1200 offers a load capacity of 1,200 kg (with corresponding suction plate). Maintenance flaps on both sides for optimum accessibility, quick-change interface for suction plates, automatic locking by gravity. All-round impact protection serves as a handle for easy levelling.

Suction Plates:

Type	Suction Plate Dimension in (mm)	Working Load Limit WLL lbs (kg)	Dead Weight lbs (kg)	Order-Number
SM-SPS-200-58/28 ❶	approx. 22.83 x 11 (580 x 280)	440 (200)	20 (8.2)	42720001
SM-SPS-400-75/27 ❶	approx. 29.52 x 10.62 (750 x 270)	880 (400)	20 (10.0)	42720002
SM-SPS-600-95/34 ❶	approx. 37.40 x 13.38 (950 x 340)	1,320 (600)	35 (15.0)	42720349
SM-SPS-800-103/39 ❶	approx. 40.55 x 15.35 (1,030 x 390)	1,764 (800)	42 (19.0)	42720455
SM-SPS-1000-99/49 ❶	approx. 38.98 x 19.29 (990 x 490)	2,205 (1,000)	51 (23.0)	42720456
SM-SPS-1200-99/59 ❶	approx. 38.98 x 23.23 (990 x 590)	2,646 (1,200)	58 (26.0)	42720457

❶ Durable surface protection by galvanizing



SM-1200

Type	Description	Drive	Dead Weight kg (lbs)	Order-Number
SM-1200 ❶	Basic device, without suction plate	by 12 V battery	40 (88)	52720009

Accessories:

Type	Description	Order-Number
SM-1200-BB ❶	Operating handle for retrofitting to the SM-1200	42720461



FLIEGUAN-ACCU-HANDY FXAH-120-GRABO-GREENLINE – the power pack for manual installation

Designed for landscape contractors and tilers, for quick and ergonomic lifting, moving and laying of absorbent concrete slabs, natural stones, tiles and other absorbent building materials. ACCU-HANDY is placed on a slab or tile, switched on, and then sucks onto the surface without any downward pressure.

The vacuum is released again by pressing another switch.

- Considerably easier laying, as there is no need to grip on the side, especially for the last slab
- Less risk of edge damage, as laying is more precise and with a better view
- Fast suction due to high air volume flow
- Manometer with negative pressure display. (Bar or PSI)
- Powered by a rechargeable 14.8 V lithium-ion battery (exchangeable battery concept)
- Battery life: approx. 1.5 to 2 h in continuous operation, in normal operation up to one day
- Increased safety through battery status LED

Scope of delivery: FXAH-120 (in box): Vacuum hand laying device, Charger (110 V)

2 x lithium-ion battery, carrying strap, spare rubber seal and spare filter.



FXAH-120-US-GREENLINE

Type	Dimensions L x W in (mm)	Battery Capacity (Ah)	Working Load Limit/WLL -700 mbar lbs (kg) Load horizontal / vertical	Dead Weight incl. battery lbs (kg)	Order-Number
FXAH-120-GRABO-US-GL	12 x 7 (300 x 180)	2.2	265 / 132 (120 / 60)	3 (1.5)	58500009

FXAH-120-GRABO-US-GL



FXAH-120 Carry Handles

With the SOLO and DUO carry handle add ons, you can work alone or in pairs in an upright position. The load is released via the foot pedal.



FXAH-120-SOLO-Set



FXAH-120-DUO-Set

Type	Dimensions L x W in (mm)	Working Load Limit/WLL lbs (kg)	Dead Weight lbs (kg)	Order-Number
FXAH-120-SOLO Set	Carry handle with adapter for one person	265 (120)	10 (4.4)	48500055
FXAH-120-DUO-Set	Carry handle with adapter for two persons	265 (120)	22 (10.1)	48500054

Vacuum Lifting Device SH-3500-B – With even greater power for harsh construction site use

- Threefold vacuum pump capacity compared with the previous standard SH-2500-UNI-B device; producing a significantly faster buildup of vacuum, also suitable for more porous elements
- Integrated Honda gas engine with electric start
- With integral chain-box and safety chain
- Suction and release operation via comfortable button-activation on the control console
- Built-in operating hours counter
- Built in fork sleeves to use with forked carriers
- All available SH-suction plates are compatible with the SH-3500-B.

**Options: Wheelset SH-3500-RS, support feet
SH-3500-AF, retrofit kit with rotator Baltrotor SH-AD
and remote control SH-3500-FFS**

Suction Plates SPS for Lifting Device SH

For different jobs we recommend special suction plates. All suction plates can be changed by means of a quick release coupling (modular principle). The carrying capacities depend on the size of the suction plate. The Probst special foam-rubber seal is suitable for all types of materials:

- Particularly good with uneven surfaces
- Extremely durable
- Changed in a flash: take the old one off, put on the new one – finished!



SH-3500-B

Type	Description	Power	Working Load Limit WLL lbs (kg)*	Dead Weight (without suction plate) lbs (kg)	Order-Number
SH-3500-B	Basic device, without suction plate	gas engine 3,6 kW	7,700 (3,500)	approx. 395 (180)	52400041
SH-3500-B-FFS	Basic device, without suction plate. With remote control	gas engine 3,6 kW	7,700 (3,500)	approx. 395 (180)	52400047

*Value at 600 mbar low pressure.

Accessories:

Type	Description	Dead Weight lbs (kg)	Order-Number
SH-3500-RS ①	Wheelset for SH-3500-B	24 (11)	42500256
SH-3500-AF	Support feet for SH-3500-B	25 (11.4)	42400579

Type	Suction Plate Dimension in (mm)	Working Load Limit WLL* lbs (kg)	Working Load Limit WLL** lbs (kg)	Order-Number
SPS-3500(2300)-174/92 ①	69 x 36 (1,740 x 920)	7,700 (3,500)	5,100 (2,300)	42400555
SPS-2500(1650)-143/78 ①	56 x 30 3/4" (1,430 x 780)	5,500 (2,500)	3,650 (1,650)	52500239
SPS-1200(800)-96/58 ①	37 3/4" x 22 3/4" (960 x 580)	2,650 (1,200)	1,760 (800)	52500162
SPS-1010(670)-84/57 ①	21 1/2" x 22 1/2" (840 x 570)	2,230 (1,010)	1,480 (670)	52500238

6 Clamps and Handling



EasyGRIP™ EXG MAXI

The EasyGRIP EXG MAXI is a perfect little clamp for small yet difficult-to-grab products such as wall block, curbs, and steps. Can be used as an attachment to a carrier (mini-ex, loader, etc.) or it can be used manually by (2) workers.

- Inside Height: 7" - 9" (17 - 22 cm)
- Gripper length: 9 1/4" (24 cm)

Type	Gripping Range* W in (mm)	Inside Height ** E in (mm)	Gripper Length L in (mm)	Working Load Limit WLL lbs (kg)	Dead Weight lbs (kg)	Order- Number
EXG 0	0 - 11 3/4" (0 - 300)	5 3/4 - 7 1/2" (125 - 195)	9 1/4" (235)	1,200 (550)	26 (12)	53100370
EXG-0 MAXI	0 - 15 3/4" (0 - 400)	6 1/2 - 8 1/2" (165 - 215)	9 1/4" (235)	1,320 (600)	33 (15)	53100392

** depending on gripping range



EasyGRIP EXG MAXI

FastGRAB™ TSZ UNI-800 & MAXI

Ideal for installation of stair treads, curbs, blocks & slabs as well as roughcut natural stone products such as outcroppings, rocks and boulders.

- Eliminates need for lifting anchors or awkward use of slings, saving you time and money.
- Automatic lock and release mechanism for maximum efficiency, clamp can quickly and easily be lifted off without aid after a product is set in place.
- Inside Height: 0" - 7" (18.5 cm)
- Gripper length: 13 3/4" (35 cm)

Type	Opening Range in (cm)	Lifting Capacity lb (kg)	Dead-Weight lbs (kg)	Order- Number
TSZ UNI-800	2" - 24" (5 - 61 cm)	1,760 lb (800 kg)	67 lb (32 kg)	53100451-003
TSZ MAXI	33 1/2" - 43" (9 - 110 cm)	1,320 lb (600 kg)	77 lb (32 kg)	53100364-003
Rock Gripper	Reduces Opening Range by 3"	-	16 lb (7 kg)	43101384
Retaining Wall Clamp Gripper	-	-	65 lb (29 kg)	40000874



TSZ UNI



TSZ MAXI



TSZ UNI

TSZ UNI w/Retaining Wall Clamp Grippers



QuickCLAMP™ FTZ-UNI, MAXI, & MULTI

World famous PROBST QuickCLAMPs eliminate the need to use lifting anchors, slings to lift or forks and pry bars to set products into position. The automatic lock and release mechanism speeds the cycle time and keeps hands clear of danger. Optional Height Adjustment Brackets work with the UNI, MAXI, & MULTI.



FTZ-MAXI-50



MAXI 25



FTZ Multi w/ Rubber Grippers



FTZ Multi w/ Rubber Grippers

The MULTI model can be customized for your application with several gripping options. First, Select your frame/specifications, then select the appropriate gripper option. Available grippers include rubber or urethane grippers, rock grippers or even our unique fluid filled retaining wall clamp gripper (for lifting multiple split faced blocks at once).

Type	Opening Range in (cm)	Inside Height in (cm)	Gripper Length in (cm)	Lifting Capacity lb (kg)	Dead-Weight lbs (kg)	Order-Number
UNI 1 (Grippers Incl)	2" - 20.5" (5 - 52 cm)	6.7" (17 cm)	16.5" (42 cm)	1,980 lb (1,500 kg)	120 lb (55)	53100120
UNI 15 (Grippers Incl)	0" - 31" (0 - 78 cm)	10" (22.5 cm)	16.5" (42 cm)	3,300 lb (1,500 kg)	200 lb (90)	53100256-003
UNI 25 (Grippers Incl)	0" - 29.5" (0 - 75 cm)	10" (25.5 cm)	16.5" (42 cm)	5,500 lb (2,500 kg)	260 lb (119)	53100313
UNI 50 (Grippers Incl)	0" - 33.5" (0 - 85 cm)	7.9" (20 cm)	28.3" (72 cm)	11,000 lb (5,000 kg)	540 lb (245)	53100362
MAXI 25 (Grippers Incl)	8" - 47" (20 - 120 cm)	10" (22.5 cm)	16.5" (42 cm)	5,500 lb (2,500 kg)	285 lb (129)	53100344
MAXI 50 (Grippers Incl)	16" - 49" (41 - 124 cm)	6.3" (16 cm)	28" (72 cm)	11,000 lb (5,000 kg)	570 lb (259)	53100363
Inside Height Adjustment Bracket Set (recommended)					3 lb (1)	43100867

Build Your Own Clamp

Type	Opening Range in (cm)	Lifting Capacity lb (kg)	Dead-Weight lbs (kg)	Order-Number
MULTI (Frame Only)		3,300 lb (1,500 kg)	210 lb (95)	53100348
16.5" Rubber Gripper Clamp Asm	8" - 49" (20 - 124 cm)	3,300 lb (1,500 kg)	30 lb (13)	43101262
Rock Gripper	8" - 47" (20 - 119 cm)	3,300 lb (1,500 kg)	75 lb (34)	43100941
48" Retaining Wall Grippers	8" - 49" (20 - 124 cm)	3,300 lb (1,500 kg)	125 lb (34)	50000000
MULTI 15 D (Frame Only)		3,300 lb (1,500 kg)	210 lb (95)	53100393
16.5" Rubber Gripper Clamp Asm	0" - 30" (0 - 76 cm)	3,300 lb (1,500 kg)	30 lb (13)	43101262
Rock Gripper	0" - 28" (0 - 71 cm)	3,300 lb (1,500 kg)	75 lb (34)	43100941
48" Retaining Wall Grippers	0" - 30" (0 - 76 cm)	3,300 lb (1,500 kg)	125 lb (34)	50000000
Height Adjustment Bracket Set (Recommended)				3 lb (1) 43100867

BoulderGRAB™ / Mechanical Boulder Grab FVZ-UNI

This is a versatile 3-point clamp alternative to hydraulic grapples. Engineered with high tensile construction. The included crane loop and lifting chain adds ease of integration with any lifting equipment. BoulderGRAB is simple to operate, reliable, and requires minimal maintenance. It is perfect for smaller projects.

- Lifting Capacity: 3300 lbs (1,500 kg)
- Opening Range: 37½ in+ (95+ cm)
- Lift chain included

Type	Opening Range in (cm)	Lifting Capacity lbs (kg)	Dead-Weight lbs (kg)	Order-Number
BoulderGRAB	37+ (95+)	3,300 (1,500)	190 (85)	53100272



BoulderGrab



Two Man BoulderGrab

Two Man BoulderGRAB™ / Manual Boulder Grab H-FVZ-UNI

Two Man BoulderGRAB features a simple opening range adjustment and loop for lifting with various construction equipment.

Type	Opening Range in (cm)	Lifting Capacity lbs (kg)	Dead-Weight lbs (kg)	Order-Number
Two Man BoulderGRAB	24+ (60+)	440 (200 kg)	46 lb (18 kg)	53200086



8

Civil Engineering: Manhole and Pipe Laying



Concrete Pipe Lifter RVD-4,5-ECO – now with an attachment option for hydraulic rotary gears such as rotators and tilt rotators

By means of the mechanical clamping mechanism pipes cannot slip off thus accurate placement can be easily effected.

- **New:** It is possible to mount an additional rotator or tilt rotator. This makes it even more flexible
- Revised, compact design
- Mandrel with plastic plate on the underside to gently push the pipe into the correct gap after installation
- Increased working load limit of 4,500 kg
- Easier pipe handling in the trench lining thanks to an optimised mandrel (compact dimensions)
- With fork sleeves for transportation with fork arms
- **Flexible:** The pipe lifter RVD--4,5-ECO can be simply attached to any excavator via the integrated, universal flange plate, using a quick-hitch coupling*
- **Simple to use:** autonomous, simple pick-up of the pipe lifter through the driver of the excavator, requires no mounting procedure, short training time for employees
- **Safe:** no personal needed for pick-up and put down the pipes, thus heavy reduction in potential hand-injuries



RVD-4,5-ECO

Type	Inner Pipe Diameter in (mm)	Maximum Length of Pipes in (mm)	Working Load Limit WLL lbs (kg)	Dead Weight lbs (kg)	Order-Number
RVD-4,5-ECO	23 – 47¼" (600 - 1,200)	118 (3,000)	9,900 (4,500)	approx. 1,300 (588)	44000184

A minimum pipe weight of 600 kg is mandatory for proper operation of the clamp.

Mounting of hydraulic rotators to RVD-4.5-ECO



1. Transport



2. Laying

* Not included in scope of delivery

With a patented safety locking system

The clamping force of the claws is fully maintained in all cases, even if the carrier is operated incorrectly.

- Gripping and laying concrete pipes
- **Patented safety locking system:** When lifting the product, the grab generates tension on the pipe, which is maintained even when the product is set down.
- One-man operation
- With adjustable height supports, which can be adjusted with a scale using the external pipe diameter. This guarantees an optimum grab position
- Slim design allows joint-sleeve pipes lying close together to be picked up onto the lorry loading area and used in very narrow trenches
- With handles to guide the claw

Round Grab RG-75/125-SAFELOCK / Round Grab RG-100/150-SAFELOCK also suitable for really large pipes

- Easy, continuous adjustment of the external diameter by means of a scale from 720 mm to 1,280 mm for the RG-75/125 and 970 mm to 1,530 mm for the RG-100/150 using threaded spindles. Crank included in the delivery
- Replaceable steel grab clamps with a reliable grip
- Optionally available: rubber gripper jaws to prevent surface damages (only RG-75/125-SAFELOCK)

Round Grab RG-20/85-SAFELOCK – the top seller now also comes with a patented safety locking system

Increased grip width of up to 870 mm and increased working load limit of 2,500 kg.

- Easy adjustment of the outer diameter by means of a scale and a central lock pin
- Rubber grippers
- Polyamide-coated height adjustment bracket

Type	Outside Diameter of Pipe D in (mm)	Gripper Length in (mm)	Working Load Limit WLL lbs (kg)	Dead Weight lbs (kg)	Order-Number
RG-20/85-SAFELOCK	8 – 34 (200 - 870)	17 (420)	5,510 (2,500)	approx. 310 (140)	54500009

● Durable surface protection by galvanizing



RG-100/150-SAFELOCK

Type	Outside Diameter of Pipe D in (mm)	Gripper Length in (mm)	Working Load Limit WLL lbs (kg)	Dead Weight lbs (kg)	Order-Number
RG-75/125-SAFELOCK ●	28½ – 50" (720 - 1,280)	17½" (440)	8,800 (4,000)	820 (370)	54500005
RG-100/150-SAFELOCK	38 - 60 (970 - 1,530)	18 (460)	13,230 (6,000)	approx. 1,210 (550)	54500008

Innovation
Now with a safety locking system, increased gripping range and higher working load limit

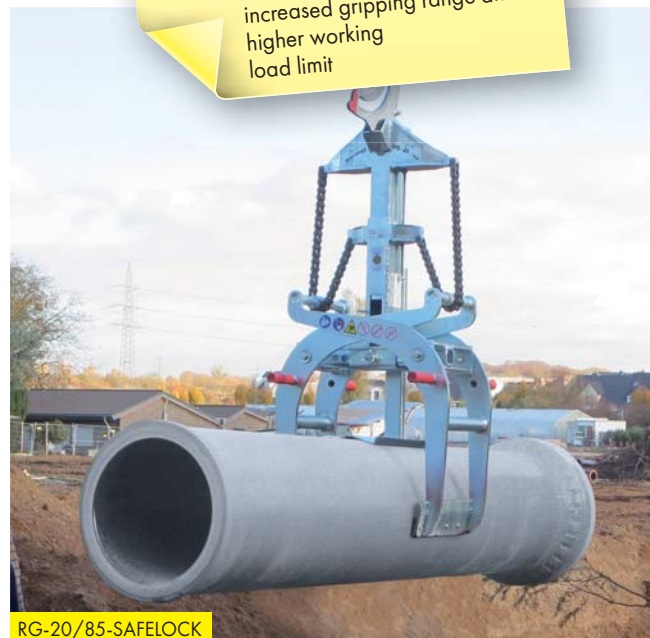

RG-20/85-SAFELOCK

Round Grab RG – 1000 times proven robustness

Simple mechanic clamp for different diameter.

- Due to the ultra slim design the grab can be used in very slender trenches
- With automatic release for fully automatic switch-over from „full“ to „empty“
- With height adjustment bars to stabilize pipes and grip them securely, up to a pipe length of 6 meters
- With changeable gripper for handling of coated and concrete pipes
- Easy adjustment of the gripping range by spring loaded bolts
- **RG-8/40**: Besides concrete pipes, vitrified clay pipes can also be gripped safely.



RG-8/40



RG-20/80

Type	Outside Diameter of Pipe D in (mm)	Gripper Length in (mm)	Working Load Limit WLL lbs (kg)	Dead Weight lbs (kg)	Order-Number
RG-8/40 ^o	3¼ – 15¾" (80 - 400)	19¾" (500)	950 (430)	100 (45)	54500004
RG-20/80 ^o	7¾ – 31½" (200 - 800)	16½" (420)	3,300 (1,500)	205 (92)	54500002

^o Durable surface protection by galvanizing

Manhole and Cone Installation Clamp SVZ-ECO – light and compact; also suitable for right-angled manholes

The SVZ-ECO is the right choice for sole installation of manhole bases and rings with a nominal diameter of 800 und 1000 mm (round and square) and cones (625 mm) or round well rings with a nominal diameter of 900 mm up to 1,700 kg.

- Can be operated solely by the excavator driver due to integrated trip mechanism for fully automatic switching between gripping and release
- Self-tensioning steel claws ensure secure gripping



Type	Manhole Bases + Rings + Cones (Cover Hole Ø 625 mm / 24¾") Nominal Value in (mm)	Working Load Limit WLL lbs (kg)	Dead Weight lbs (kg)	Order- Number
SVZ-ECO ①	31½ + 39 (800 + 1,000)	3,700 (1,700)	115 (52)	54000032

SVZ-ECO-L



Manhole and Cone Installation Clamp SVZ-ECO-L – Manhole elements up to a nominal diameter of 1,200 mm can now be gripped reliably

With the new, compact and extremely robust SVZ-ECO-L manhole installation clamp (the big brother of the SVZ- ECO), manhole rings with a nominal diameter of 700, 800, 900, 1,000, 1,050 or even 1,200 mm and cones (625 mm) can now be installed quickly, easily and safely.

- With positioning aid for quick and reliable positioning of the clamp in the manhole elements
- All manhole elements including **cones hang completely level** due to movable suspension
- With automatic release

Type	Manhole Bases + Rings + Cones (Cover Hole x 625 mm / 24¾") Nominal Value in (mm)	Working Load Limit WLL lbs (kg)	Dead Weight lbs (kg)	Order- Number
SVZ-ECO-L ①	27½" / 31½" / 35½" / 39" / 41" / 47" (700/800/900/1.000/1.050/1,200)	4,400 (2,000)	185 (85)	54000034

① Durable surface protection by galvanizing

9 Highrise and Yard Handling



Scissor Grab SG – the traditional mechanical grab to move block packs around the jobsite

- Fast transfer of un-palletized paving stone or kerb stone packs with vertical strapping (each row) from the storage to the installation site; saves time and money
- With automatic release
- The height-adjustable support allows transport even of individual kerb layers

In the event of wear on the outer ends of the rubber grippers, it is also possible to replace only these end areas.

Optional available accessories: fork pockets ET-D/DB to insert stacking forks and eyelet EH for hoist operation



SG

Type	Working Load Limit WLL lbs (kg)	Order-Number
ET-D, with additional lifting eye for crane hook	5,500 (2,500)	43100411

Type	Gripping Range * W in (mm)	Inside Height E in (mm)	Gripper Length L in (mm)	Working Load Limit WLL lbs (kg)	Dead Weight lbs (kg)	Order-Number
SG-60-PGL2	15 3/4 - 43 (400 - 1,100)	23 1/2" (600)	47 (1,200)	4,000 (1,800)	420 (190)	53100415
SG-100-PGL2	27 1/2 - 47 (700 - 1,200)	39 (1,000)	47 (1,200)	4,400 (2,000)	840 (380)	53100284



TSZ-UNI-ET

Concrete Step Handles TSZ-UNI-ET with fork sleeves

Suitable for picking and moving steps, kerbstones, block steps and edge angles with a wheel loader or forklift truck.

- Easily adjustable opening width by means of a spring-loaded bolt
- Considerable inside height. Conical kerb stones are also gripped securely, as the gripper has an inside height of 185 mm (7 1/4 inch) thus being able to grip underneath the conical form
- Fork sleeve with lifting eye and manual turning device, engaging every 90°. Thus the TSZ-UNI can be picked-up with the fork lift truck tines
- Automatic release for fully automatic switch-over from "full" to "empty"
- Exchangeable profiled rubber seals
- Can also be used for crane hooks, for example
- Galvanised finish

Type	Gripping Range W in (mm)	Inside Height E in (mm)	Gripper Length L in (mm)	Working Load Limit WLL lbs (kg)	Dead Weight lbs (kg)	Order-Number
TSZ-UNI-ET	2 - 23.62 (50 - 600)	7.28 (185)	13.77 (350)	1,320 (600)	95 (43)	53100443





making hard work easier

Headquarter/Production

Probst GmbH
Gottlieb-Daimler-Straße 6
71729 Erdmannhausen / Germany
Phone +49 7144 3309-30
info@probst-handling.de

Probst USA

Probst Inc.
8626 Hollander Dr
Franksville, WI 53126
Office: 952-226-6400
sales@probst-handling.com

Probst Canada

Probst Handling Equipment Corp.
1208 Gorham St. Unit#3
Newmarket, Ontario L3Y8Y9
Office 437-600-8816
sales@probst-handling.ca

www.probst-handling.com